













-  Pressa idraulica da banco con pistone mobile
-  Hydraulic workbench press with moveable piston
-  Hydraulische Standpresse mit verschiebbarem Kolben
-  Presse hydraulique d'établi avec piston mobile
-  Prensa hidráulica de banco con pistón móvil



PR15BPM

-  Pompa a mano a due velocità • Sicurezza idraulica in caso di sovraccarico • Ritorno automatico del pistone • Stelo cromato • Manometro • Serie di prismi a V
-  Double-speed hand pump • Overload safety-valve • Automatic return of the ram • Chromium plated rod • Pressure gauge • V-blocks
-  Zweistufige Handpumpe • Überlastsicherung • Automat. Kolbenrücklauf • Verchromte Kolbenstange • Manometer • V-Prismen
-  Pompe manuelle double vitesse • Sécurité hydraulique en cas de surcharge • Retour automatique du piston • Tige chromée • Manomètre • Jeu de prismes à V
-  Bomba de mano con dos velocidades • Seguridad hidráulica en caso de sobrecarga • Retorno automático del pistón • Vástago cromado • Manómetro • Serie de prismas en V

PR10BPM - PR15BPM

10-15 t



Dati tecnici

Technical data

Technische Eigenschaften

Caractéristiques techniques

Datos técnicos

	PR10BPM	PR15BPM
A	1250	1350
B	620	690
C	500	500
D	500	550
E	150	150
F	500	550
G	160	160
H	820	900
L	300	340
kg	90	105

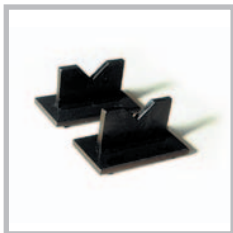
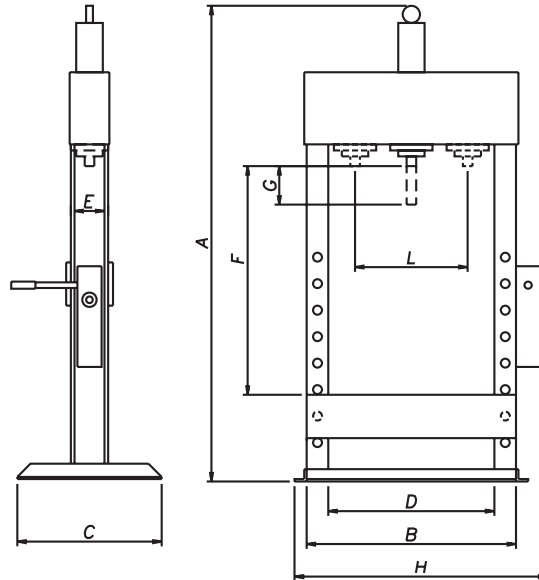

Prismi
V-blocks
Prismensatz
Prismes à 'V'
Prismas



Opzioni

Optionals

Sonderzubehör

Options

Opcionales



Piastra cacciaspine
Press plate
Abdrückplatte
Plaque d'extraction
Placa extractora de pasadores



Ø 29 24 18 14 10 5
Kit punzoni
Plugs
Stempelset
Kit de poinçons
Juego de punzones