



yellow energy



Saldatura e taglio plasma

Welding & plasma cutting



Storia di qualità e innovazione

Story of quality and innovation

Da oltre 50 anni Deca persegue tenacemente la propria passione: progettare e costruire prodotti affidabili, prestazionali e all'avanguardia.

Essere il fabbricante degli impianti che proponiamo ci permette di avere il pieno controllo di tutti i processi: ideazione, progettazione, industrializzazione, produzione e controllo qualità.

Il punto focale del nostro operato è quello di offrire strumenti in grado di soddisfare appieno le esigenze degli utilizzatori operando nel rispetto delle stringenti normative europee di prodotto e delle leggi nazionali per la tutela dei nostri lavoratori e di chi utilizzerà i nostri prodotti.

For over 50 years, DECA has tenaciously pursued its own passion: designing and manufacturing reliable, high-performance and advanced products.

Being the manufacturer of the equipments that we offer allows us to have full control over all processes: conception, design, industrialization, production and quality control.

The focal point of our work is to offer tools that can fully meet the needs of their users, operating in compliance with the strict European regulations on products and with the national laws for the protection of our workers and of anyone who will use our products.



MADE IN SAN MARINO
AT THE CENTER OF ITALY



Siamo costantemente rivolti al miglioramento della qualità e della sua fruizione.
L'adozione di intuitive interfacce del pannello comandi rende facile la comprensione del funzionamento.
Sofisticati software, sviluppati in collaborazione con esperti del settore, ottimizzano le funzioni.

*We aim to constant improvement of quality and of its fruition.
The adoption of intuitive interfaces of the control panel makes it easy to understand their functioning.
Sophisticated software, developed in collaboration with experts in the field, optimize their functions.*

Una vasta gamma di programmi pre-impostati supporta attivamente l'utilizzatore meno esperto ed agevola il lavoro ai professionisti. Parallelamente l'ampia possibilità di adattamento dei parametri permette un settaggio personalizzato per ottimizzare ogni impianto allo specifico impiego.

A wide range of pre-set programs actively supports the less experienced user and facilitates the work of professionals. Simultaneously the wide possibility of adapting parameters allows a customized setting to optimize each equipment for the specific use.

L'utilizzo di hardware sviluppati internamente consente la realizzazione di prodotti solidi ed affidabili nel tempo. Sempre sotto il nostro diretto controllo per essere prontamente migliorati ed implementati con i più recenti avanzamenti tecnologici.
La padronanza a 360° delle competenze e conoscenze ci permette di essere un valido supporto ai nostri distributori e alla loro clientela, mediante attività di assistenza tecnica e di training sia presso il nostro centro di formazione sia fuori sede.

*The use of in-house developed hardware enables the creation of sturdy and reliable products over time. Always under our direct control to be promptly improved and implemented with the latest technological advances.
The 360-degree mastery of expertise and knowledge allows us to be a valid support to our distributors and their customers, through technical assistance and training activities both at our training centre and of site.*

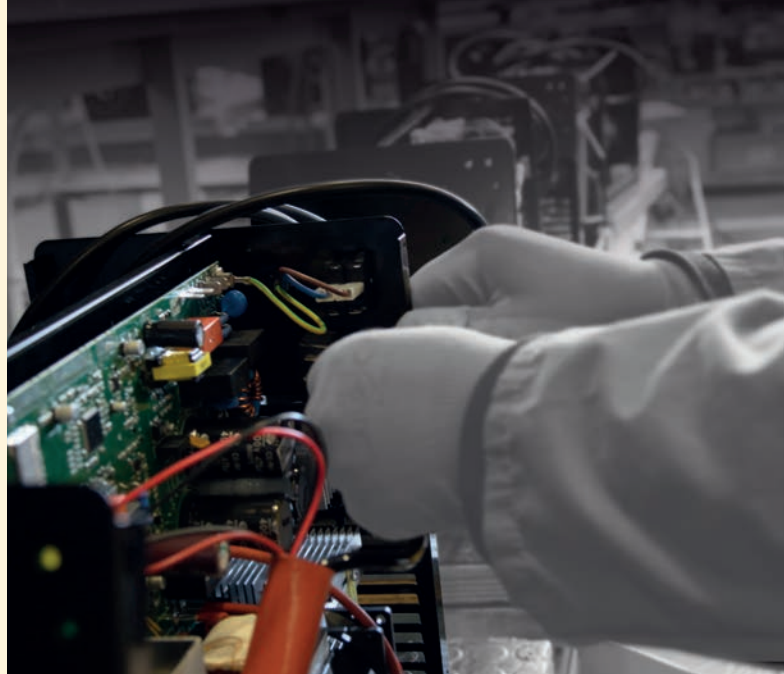



Il piacere di Saldare

The pleasure of Welding

INVERTER

pag.

TRADITIONAL

pag.



MMA

8

26



TIG

14

-



MIG/MAG

16

27



PAC

24

-

Saldare per mestiere

Weld for work



MMA

32

68



TIG

40

-



MIG/MAG

46

70



PAC

64

76



SPOT WELDER

78



DENT PULLER

80



DRAWN ARC

84



STUD ALU

86



Accessori - Accessories

95

Note tecniche - Technical tips

113

Il piacere di Saldare

The pleasure of Welding





deca®

MMA INVERTER

 Utilizzo leggero
 Light duty
 Manutenzione
 Maintenance

- SIL è la gamma di saldatrici inverter MMA e TIG pensata per un utilizzo leggero come riparazioni e piccole operazioni di saldatura sia in officina che in esterno.
- Il design compatto ed il peso ridotto le rendono perfette per il trasporto.
- Facili da usare con una unica manopola di comando.
- Offrono eccellenti proprietà d'innesco ed un arco stabile.
- Sono indicate per la saldatura su acciaio dolce e inox con elettrodi rutili, basici, inox, ecc.
- Permettono la saldatura TIG DC con innesco a striscio (SIL 415, SIL 417).

- SIL is a range of MMA and TIG inverter welders designed for light duty: maintenance and minor welding operations both in the workshop and outdoors.
- The compact design and the light weight make the SIL range perfect to bring along.
- Only one knob – simple to operate.
- The machines have excellent ignition properties and a stable arc.
- SIL welders are applicable for mild and stainless steel welding operation with rutile, basic, inox electrodes, etc.
- They allow TIG DC welding with scratch arc striking (SIL 415, SIL 417).

****SIL 313 - 415 - 417 Promotion Pack**

Auto Darkening DIN 11

 SIL
 Accessori e valigetta
 Accessories and carry case



MADE IN SAN MARINO



		SIL 208	SIL 313	SIL 415	SIL 417
Tensione di alimentazione - Input voltage		1 ph - 230V 50/60 Hz			
Potenza assorbita - Absorbed power: 60% / Max		0,9 / 2,2 kW	1,0 / 3,4 kW	1,1 / 4,0 kW	1,5 / 4,9 kW
Fusibile - Fuse		16A	16A	16A	16A
Generatore - Generator		+/- 15% (3 kW)	+/- 15% (5 kW)	+/- 15% (6 kW)	+/- 15% (7 kW)
Rendimento - Efficiency		> 80%	> 80%	> 80%	> 80%
Campo di regolazione - Welding current		MMA DC	MMA DC	MMA DC	MMA DC
10 - 80A		10 - 130A	10 - 150A	10 - 170A	
Servizio DECA 20°C - DECA use 20°C		80A - 50%	125A - 60%	150A - 60%	170A - 48%
Servizio 40°C - Duty cycle 40°C EN 60974-1		80A - 7%	125A - 7%	140A - 7%	160A - 8%
Tensione a vuoto - Open circuit voltage		85V	85V	102V	102V
MMA / TIG Elettrodi : ø mm Electrodes: ø mm	Rutile	1,6 - 2,5	1,6 - 3,2	1,6 - 4,0	1,6 - 4,0
	Basico - Basic	-	2,0 - 2,5	2,0 - 3,2	2,0 - 4,0
	TIG	-	-	1,6	1,6
Connessioni in uscita - Output connection		Cavi diretti Direct cables	DX 25 mmq	DX 25 mmq	DX 25 mmq
Protezione termostatica - Thermostatic Protection		•	•	•	•
Peso - Weight ≈		2,9 kg	2,6 kg	3,2 kg	3,3 kg
Dimensioni - Dimensions		290 x 131 x 207 mm		337 x 132 x 207 mm	
Codice - Code		279280	279380	279780	279880
** Promotion Pack			279391	279791	279891

Accessori in dotazione - Supplied accessories:



Accessori - Accessories MMA pag.99

Optional and Consumable					
Elettrodi / Electrodes Rutile 1,6mm 40pc 010220 2,0mm 40pc 010221 2,5mm 30pc 010222 3,2mm 16pc 010223 Basico / Basic 2,5mm 30pc 010127 3,2mm 30pc 011042 Inox / Stainless steel 2,0mm 40pc 010128 2,5mm 30pc 010129		Bacchette TIG / TIG rods L. 330mm Kg 0,33 Inox 308L 1,6mm 011264	(a) (b)	Kit per saldare TIG Include i componenti: TIG welding kit It includes references: (a) 011264 (b) 010614 (c) 010810 (d) 010515	(a) Inox (b) (c) (d)
		Torcia TIG / TIG Torch TG9 110A - 3m Dx 25mmq (1,6 WR2 acciaio-steel) 010614			
Posizionatore Position holder (1) MPH 92 010346 (2) MPH 62 010345	92mm 58mm (1) (2)	Regolatore di pressione Pressure regulator (M10) 010515	(d)	WM24 DIN 11 Filtro auto-oscurante 90x34mm Auto-darkening filter 90x34mm 010402	
Martellina Hammer 010341		Bombola non ricaricabile Not refillable bottle (M10) Argon 1L 010503			
Spazzola Brush 010343					

Funzioni MMA

- **Hot Start:** Eroga ampere aggiuntivi per i primi secondi quando si innesca l'arco. Aiuta ad ottenere la giusta temperatura del bagno di saldatura.
 - **Arc Force:** Riduce il rischio d'incollare l'elettrodo al pezzo da saldare.
 - **Anti-sticking:** Nel caso in cui l'elettrodo si incollò al pezzo da saldare, la corrente di saldatura è ridotta a pochi ampere per rendere più facile il distacco dell'elettrodo.
- Funzioni TIG (SIL 415, SIL 417)**
- TIG con innesco a striscio (Torcia con rubinetto).

MMA Features

- **Hot Start:** It provides extra amps for the first seconds when igniting the arc. It helps create the right temperature in the weld pool.
 - **Arc Force:** It reduces the risk of the electrode sticking to the weld pool.
 - **Anti-sticking:** In case the electrode sticks to the weld pool, the welding current will be decreased to few amps, making it easy to break off the electrode.
- TIG Features (SIL 415, SIL 417)**
- TIG with scratch arc striking (Torch with gas valve).

MMA INVERTER

Utilizzo leggero
Light duty
Manutenzione
Maintenance



SIL 417 GEN SPECIALE GENERATORE GENERATOR USE



SIL 417 GEN e SILTIG 415 sono saldatrici inverter MMA e TIG maneggevoli e pratiche, destinate alle piccole manutenzioni ma anche all'intervento d'emergenza professionale.

- Offrono eccellenti proprietà d'innesco ed un arco stabile.
- Sono indicate per la saldatura su acciaio dolce e inox con elettrodi rutili, basici, inox, ecc.

Due modelli con caratteristiche particolari.

- **SIL 417 GEN:** particolarmente adatta per interventi in assenza di rete elettrica e quindi alimentata con motogeneratore.
- **SILTIG 415:** per il saldatore più esigente.
- **Display** per la regolazione dei parametri di saldatura.
- **Hot Start** ed **Arc force** regolabili.
- **TIG con innesco LIFT.** L'elettrodo al tungsteno viene appoggiato alla superficie da saldare, sollevandolo poi lentamente per innescare l'arco di saldatura. Il passaggio di corrente a bassa intensità permette di non rovinare l'elettrodo mentre la saldatrice incrementa progressivamente l'ampereaggio.

SIL 417 GEN and SILTIG 415 are handy and practical MMA and TIG inverter welders, intended for small repair as well as professional emergency interventions.

- The machines have excellent ignition properties and a stable arc.
- These models are applicable for mild and stainless steel welding operations with rutile, basic, inox electrodes, etc.

Two models with special features.



- **SIL 417 GEN:** specifically suitable for use with an engine generator for on site work.
- **SILTIG 415:** for a more demanding welder.
- **Display** for adjusting welding parameters.
- Adjustable **Hot Start** and **Arc force**.
- **TIG with LIFT arc striking.** The tungsten electrode is placed on the surface to be welded and by lifting it slowly to strike the welding arc. The passage of low intensity current allows not to ruin the electrode while the welding machine progressively increases the amperage.



SIL 417 GEN
Accessori e valigetta
Accessories and carry case



SILTIG 415
Accessori e valigetta
Accessories and carry case

 MADE IN SAN MARINO		SIL 417 GEN	SILTIG 415
Tensione di alimentazione - Input voltage	1 ph - 230V 50/60 Hz		
Potenza assorbita - Absorbed power: 60% / Max	1,4 / 4,9 kW	1,1 / 4,0 kW	
Fusibile - Fuse	16A	16A	
Generatore - Generator	+/- 30% (7 kW)	+/- 15% (7 kW)	
Rendimento - Efficiency	> 80%	> 80%	
Campo di regolazione - Welding current	MMA DC	MMA DC	TIG DC
	10 - 170A	10 - 150A	10 - 150A
Servizio DECA 20°C - DECA use 20°C	170A - 48%	150A - 60%	150A - 60%
Servizio 40°C - Duty cycle 40°C EN 60974-1	160A - 8%	140A - 7%	140A - 10%
Tensione a vuoto - Open circuit voltage	102V	102V	
MMA / TIG	Rutile	1,6 - 4,0	1,6 - 4,0
Elettrodi : ø mm	Basico - Basic	2,0 - 4,0	2,0 - 3,2
Electrodes: ø mm	TIG	1,6	1,6
Connessioni in uscita - Output connection	DX 25 mmq	DX 25 mmq	
Protezione termostatica - Thermostatic Protection	•	•	
Peso - Weight ≈	3,3 kg	3,3 kg	
Dimensioni - Dimensions	337 x 131 x 207 mm	337 x 131 x 207 mm	
Codice - Code	278980	279180	

SIL 417 GEN Funzioni

- Speciale per uso con generatore.
- Hot Start.
- Arc Force.
- Anti-sticking.
- TIG con innesco a striscio (Torch con rubinetto).

SILTIG 415 Funzioni

- Display digitale.
- Hot Start regolabile.
- Arc Force regolabile.
- Anti-sticking.
- TIG innesco LIFT (Torch con rubinetto).

SIL 417 GEN Features

- Specifically suitable for generator.
- Hot Start.
- Arc Force.
- Anti-sticking.
- TIG with scratch arc striking (Torch with gas manual valve).

SILTIG 415 Features

- Digital display.
- Adjustable Hot Start.
- Adjustable Arc Force.
- Anti-sticking.
- TIG with LIFT arc striking (Torch with manual gas valve).





SIL 417 GEN: Accessori in dotazione - Supplied accessories:

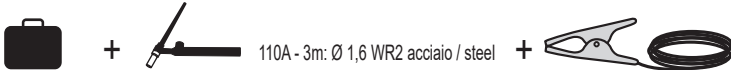

SILTIG 415: Accessori in dotazione - Supplied accessories:

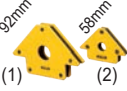

Accessori - Accessories MMA pag.99

Optional and Consumable					
Elettrodi / Electrodes Rutile 1,6mm 40pc 010220 2,0mm 40pc 010221 2,5mm 30pc 010222 3,2mm 16pc 010223 Basico / Basic 2,5mm 30pc 010127 3,2mm 30pc 011042 Inox / Stainless steel 2,0mm 40pc 010128 2,5mm 30pc 010129		Bacchette TIG / TIG rods L. 330mm Kg 0,33 Inox 308L 1,6mm 011264	 (a)	Kit per saldare TIG Include i componenti: TIG welding kit It includes references: (a) 011264 (b) 010614 (c) 010810 (d) 010515	 (a)
Posizionatore Position holder (1) MPH 92 010346 (2) MPH 62 010345	 (1) 92mm (2) 58mm	Kit attacco bombola non ricaricabile Kit Adapter not refillable bottle 010810	 (c)	Guanti (T10) Gloves (S10) 010963	 (d)
Martellina / Hammer 010341 Spazzola / Brush 010343		Regolatore di pressione Pressure regulator (M10) 010515	 (d)	WM24 DIN 11 Filtro auto-oscurante 90x34mm Auto-darkening filter 90x34mm 010402	
Pinza porta elettrodo Electrode holder 160A + 1,7m + DX25 010060		Bombola non ricaricabile Not refillable bottle (M10) Argon 1L 010503			

i-ARC Heavy Duty

DC
-+

MMA INVERTER



Manutenzione
Maintenance
Carpenteria leggera
Light carpentry
Cantiere edile
Construction site

i-ARC 217 GEN **SPECIALE GENERATORE** GENERATOR USE



i-ARC 2 è la gamma di saldatrici inverter MMA e TIG per il lavoro in officina, in cantiere e per tutte le applicazioni che richiedono qualità di esecuzione ed un ciclo di lavoro idoneo.

- Potenti e affidabili, sono saldatrici che non deludono chi le usa. Offrono eccellenti proprietà d'innesco ed un arco stabile.
- Sono indicate per le operazioni di saldatura di acciaio dolce e inox con elettrodi rutili, basici, inox, ecc.

Tre modelli con caratteristiche particolari.

i-ARC 215: ciclo di lavoro elevato per la sua categoria.

i-ARC 217 GEN: particolarmente adatta per interventi in assenza di rete elettrica e quindi alimentata con motogeneratore.

i-ARC 216D per un saldatore esigente.

- **Display** per la regolazione dei parametri di saldatura.
- **Hot Start ed Arc Force regolabili.**
- **TIG con innesco LIFT.** L'elettrodo al tungsteno viene appoggiato alla superficie da saldare, sollevandolo poi lentamente per innescare l'arco di saldatura. Il passaggio di corrente a bassa intensità permette di non rovinare l'elettrodo mentre la saldatrice incrementa progressivamente l'ampereaggio.

i-ARC 2 is a range of MMA and TIG inverter welders for the workshop, construction site and for all applications that require quality of execution and a higher duty cycle.

- Powerful and reliable, they are welding machines that do not disappoint those who use them. They have excellent ignition properties and a stable arc.
- i-ARC 2 are applicable for mild and stainless steel welding operation with rutilic, basic, inox electrode, etc.

Three models with special features.

i-ARC 215: heavy duty cycle in its category.

i-ARC 217 GEN: Specifically suitable for use with an engine generator for on-site work.

i-ARC 216D: for a more demanding welder.

- It offers a **display** for the adjustment of the welding parameters.
- **Adjustable Hot Start and Arc Force.**
- **TIG with LIFT arc striking.** The tungsten electrode is placed on the surface to be welded and by lifting it slowly to strike the welding arc. The passage of low intensity current allows not to ruin the electrode while the welding machine progressively increases the amperage.



i-ARC
Accessori e valigetta
Accessories and carry case



MADE IN SAN MARINO



		i-ARC 215	i-ARC 216D	i-ARC 217 GEN
Tensione di alimentazione - Input voltage		1 ph - 230V 50/60Hz		
Potenza assorbita - Absorbed power: 60% / Max		2,8 / 4,0 kW	2,8 / 4,8 kW	2,8 / 4,9 kW
Fusibile - Fuse		16A	16A	16A
Generatore - Generator		+/- 15% (6kW)	+/- 15% (7 kW)	+/- 30% (7 kW)
Rendimento - Efficiency		> 80%	> 80%	> 80%
Campo di regolazione - Welding current		MMA DC	MMA DC	TIG DC
Campo di regolazione - Welding current		10 - 150A	10 - 160A	10 - 160A
Servizio DECA 20°C - DECA use 20°C		150A - 60%	160A - 60%	-
Servizio 40°C - Duty cycle 40°C EN 60974-1		150A - 25%	160A - 20%	160A - 25%
Tensione a vuoto - Open circuit voltage		88V	88V	88V
MMA / TIG Elettrodi : ø mm Electrodes: ø mm	Rutile	1,6 - 4,0	1,6 - 4,0	1,6 - 4,0
	Basico - Basic	2,0 - 3,2	2,0 - 3,2	2,0 - 4,0
	TIG	1,0 - 4,0	1,0 - 4,0	1,0 - 4,0
Connessioni in uscita - Output connection		DX 25 mmq	DX 25 mmq	DX 25 mmq
Protezione termostatica - Thermostatic Protection		•	•	•
Peso - Weight =		4 kg	4 kg	4 kg
Dimensioni - Dimensions		369 x 134 x 207 mm	369 x 134 x 207 mm	369 x 134 x 207 mm
Codice - Code		285680	286480	285780

Accessori in dotazione - Supplied accessories:

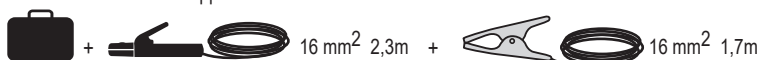

Accessori - Accessories MMA pag.99

Optional and Consumable					
Elettrodi / Electrodes Rutile 1,6mm 40pc 010220 2,0mm 40pc 010221 2,5mm 30pc 010222 3,2mm 16pc 010223 Basico / Basic 2,5mm 30pc 010127 3,2mm 30pc 011042 Inox / Stainless steel 2,0mm 40pc 010128 2,5mm 30pc 010129		Bacchette TIG / TIG rods L. 330mm Kg 0,33 Inox 308L 1,6mm 011264	(a)	Kit per saldare TIG Include i componenti: TIG welding kit It includes references: (a) 011264 (b) 010614 (c) 010810 (d) 010515	(a)
		Torcia TIG / TIG Torch TG17 140A - 4m Dx25/50mmq (1,6 WR2 acciaio-steel) 010068	(b)	Kit attacco bombola non ricaricabile Kit Adapter not refillable bottle 010810	(c)
Posizionatore Position holder (1) MPH 92 010346 (2) MPH 62 010345	(1) 92mm (2) 58mm	Regolatore di pressione Pressure regulator (M10) 010515	(d)	WM27 DIN 9-13 Filtro auto-oscurante 93x43mm Auto-darkening filter 93x43mm	
Martellina / Hammer 010341 Spazzola / Brush 010343		Bombola non ricaricabile Not refillable bottle (M10) Argon 1L 010503		Pinza porta elettrodo Electrode holder 200A + 2,7m 16mmq + DX25 010069	

i-ARC 215 Funzioni MMA e TIG

- Hot Start, Arc Force, Anti-sticking.
- TIG con innesco a striscio (Torcia con rubinetto).

i-ARC216D Funzioni MMA e TIG

- Display digitale.
- Hot Start e Arc Force regolabili.
- Anti-sticking.
- TIG con innesco a Lift (Torcia con rubinetto).

i-ARC 217 Gen Funzioni MMA e TIG

- Speciale per uso con generatore.
- Hot Start, Arc Force, Anti-sticking.
- TIG con innesco a striscio (Torcia con rubinetto).

i-ARC 215 MMA and TIG Features

- Hot Start, Arc Force, Anti-sticking.
- TIG: Torch with gas valve and scratch arc striking.

i-ARC216D MMA and TIG Features

- Digital display.
- Adjustable Hot Start and Arc Force.
- Anti-sticking.
- TIG: Torch with gas valve and LIFT arc striking.

i-ARC 217 Gen MMA and TIG Features

- Specifically suitable for generator .
- Hot Start, Arc Force, Anti-sticking
- TIG: Torch with gas valve and scratch arc striking.

TIG INVERTER

- Manutenzione
Maintenance
- Carpenteria leggera
Light carpentry
- Autoriparazioni
Automotive
- Saldatura di precisione
Precision welding



i-TIG
SPECIALE GENERATORE
GENERATOR USE



Le i-TIG sono saldatrici inverter TIG DC, TIG pulsato (i-TIG 320) ed MMA progettate per le operazioni di saldatura più complesse. Idonee per saldare acciaio dolce, inox, rame, ghisa e titanio. Sono saldatrici eccellenti per l'installatore e per l'uso in officina.

- L'intuitivo pannello di controllo presenta tasti con icone e un display digitale che mostra l'amperaggio o i valori delle funzioni secondarie. Consente di selezionare e regolare con facilità i parametri desiderati.
- L'innesco è ad alta frequenza **HF** o **LIFT** che permette di saldare nei pressi di dispositivi elettronici sensibili.
- La funzione **TIG pulsata** offre un controllo migliore del bagno di saldatura, soprattutto per la saldatura in posizione o di laminati metallici.
- La funzione **EASY PULSE** regola automaticamente la corrente base e la frequenza di pulsazione in funzione della corrente di picco impostata. Semplifica considerabilmente il processo di saldatura TIG in corrente alternata.

i-TIG are TIG DC, pulse TIG (i-TIG 320) and MMA inverter welding machines designed for complex welding operations in the field. Suitable for welding in mild steel, stainless steel, copper, cast iron and titanium. They are ideal for workshop use and on-site welding operations.

- The intuitive control panel consists of icon-based buttons and a digital display showing amperage, voltage or secondary parameters. It allows to easily select and adjust the desired parameters.
- **High-frequency or LIFT** ignition allows to weld near sensitive electronic devices.
- The **TIG pulse function** provides better control of the weld pool. This applies in particular when used for position welding or sheet metal welding.
- The **EASY PULSE** feature automatically adjusts base current and pulsation frequency according to the set peak current. It considerably simplifies the TIG welding process with alternating current.

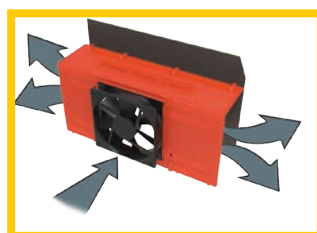

Ventilazione ad alte prestazioni
High performance air cooling



MADE IN SAN MARINO		CE		i-TIG 318		i-TIG 320	
Tensione di alimentazione - Input voltage				1 ph - 230V 50/60 Hz			
Potenza assorbita - Absorbed power: 60% / Max				3,3 / 4,9 kW		3,3 / 5,8 kW	
Fusibile - Fuse				20A		20A	
Generatore - Generator				+/- 30% (7 kW)		+/- 30% (7 kW)	
Rendimento - Efficiency				>80%		>80%	
Campo di regolazione - Welding current				TIG DC	MMA DC	TIG DC	MMA DC
Servizio 40°C - Duty cycle 40°C EN 60974-1				10 - 180A	10 - 160A	10 - 200A	10 - 180A
				180A - 30%	160A - 30%	200A - 20%	180A - 20%
				140A - 60%	130A - 60%	140A - 60%	130A - 60%
Tensione a vuoto - Open circuit voltage				90V		90V	
MMA / TIG		Rutile		1,6 - 4,0		1,6 - 4,0	
Elettrodi : ø mm		Basico - Basic					
Electrodes: ø mm		TIG		1,0 - 4,0		1,0 - 4,0	
Connessioni in uscita - Output connection				DX 25 mmq		DX 25 mmq	
Ventilata - Fan cooled				Convoir Cooling System		Convoir Cooling System	
Protezione termostatica - Thermostatic Protection				•		•	
Peso - Weight ≈				6,7 kg		6,7 kg	
Dimensioni - Dimensions				428 x 160 x 273 mm		428 x 160 x 273 mm	
Codice - Code				286100		286300	

Accessori in dotazione - Supplied accessories

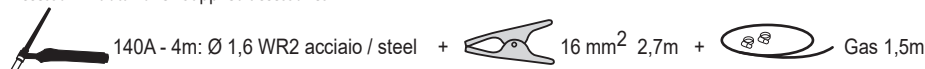

Funzioni TIG

- Arco con innesco LIFT o HF.
 - Corrente DC.
 - Corrente DC pulsata con funzione EasyPulse (i-TIG 320).
 - Pre-gas e Post-gas regolabili.
 - Slope up e Slope down regolabili.
 - Modo pulsante torcia: 2/4T; Spot (Spot solo per i-TIG 320).
 - Predisposizione per comando a pedale.
- #### Funzioni MMA
- Hot Start, Arc Force, Anti-sticking.
 - Alimentazione da rete o da generatore.

TIG Features

- LIFT or HF arc striking.
- DC current.
- DC current with pulse and EasyPulse function (i-TIG 320).
- Adjustable Pre-gas and Post-gas.
- Adjustable Slope up and Slope down.
- Torch trigger mode: 2/4T; Spot (Spot i-TIG 320 only).
- Ready for foot control.

MMA Features

- Hot start, Arc Force, Anti-sticking.
- Power supply from mains or generator.

Accessori - Accessories TIG pag.102

Optional and Consumable					
Bacchette TIG / TIG rods L. 1000mm Kg 1,0 Inox 308L 1,6mm 011255 Inox 316L 1,6mm 011256 Inox 309L 1,6mm 011257		Elettrodi / Electrodes Rutile 1,6mm 40pc 010220 2,0mm 40pc 010221 2,5mm 30pc 010222 3,2mm 16pc 010223 Basico / Basic 2,5mm 30pc 010127 3,2mm 30pc 011042 Inox /Stainless steel 2,0mm 40pc 010128 2,5mm 30pc 010129		WM31 TC True Colour / Grinding DIN 9-13 Filtro auto-oscurante a colori reali 93x43mm True colour auto-darkening filter 93x43mm 010408	
Starter Kit per acciaio Starter kit for steel 2,4mm WR2 010072		Pinza porta elettrodo Electrode holder 200A + 2,7m 16mmq + DX25 010069		Guanti (T10) Gloves (S10) 010963	
Regolatore di pressione + adattatore CO2<->Ar (IT / USA) Pressure regulator + adapter CO2 <-> Ar (IT / USA) 010832		Martellina / Hammer 010341 Spazzola / Brush 010343		CR26 Carrello / Trolley 010890	
Comando a pedale 9mt. Foot control 9mt. 010378		Posizionatore Position holder (1) MPH 92 010346 (2) MPH 62 010345			

MIGA 200

MULTIPROCESS MIG / MAG - NO GAS - MMA INVERTER

NEW!



SPECIALE GENERATORE
GENERATOR USE

Utilizzo leggero
Light duty
Manutenzione
Maintenance
Carpenteria leggera
Light carpentry
Autoriparazioni
Automotive

 Ø 100
1 kg MAX

MIGA 200 è una saldatrice inverter monofase portatile ed utilizzabile per saldature MIG/MAG, NO GAS e MMA.

Estremamente compatta e potente, è progettata per lavori di manutenzione e riparazione.

- Il pannello di controllo è semplice da utilizzare: è sufficiente selezionare la velocità del filo, la tensione dell' arco e si è pronti a saldare.
- **CONTROLLO SINERGICO:** Il microprocessore che controlla la macchina provvede a regolare l'induttanza e gli altri parametri di saldatura.
- Il cambio di polarità per saldare con filo animato (NO GAS) rende la saldatura in esterno più semplice. Il filo animato contiene al suo interno una sostanza che crea la protezione gassosa e quindi non richiede la bombola del gas.
- **MIGA 200** è l'ideale per saldare a filo su acciaio, inox ed alluminio.
- **MIGA 200** è anche un'ottima saldatrice ad elettrodo con eccellenti proprietà d'innesco ed un arco stabile. E' indicata per le operazioni di saldatura di acciaio dolce e inox con **elettrodi rutili, basici, inox, ecc.**

MIGA 200 is a portable single-phase inverter welding machine and suitable for MIG/MAG, NO GAS and MMA welding operations.

Extremely compact and powerful, this machine is designed for small works and minor repairs.

- **User-friendly control panel** by just setting voltage and wire feed speed. The machine is ready to weld.
- **SYNERGIC CONTROL:** The microprocessor which controls the machine regulates inductance and other welding parameters.
- **Reversed polarity** for welding with innershield wire (NO GAS) is a standard feature that makes outdoor welding less complicated. The innershield wire is comprised of welding material and flux that create its own gas shield. This means no need for a gas cylinder.
- **MIGA 200** is ideal to operate on steel, stainless steel and aluminum.
- **MIGA 200** is also an outstanding electrode welding machine with excellent ignition properties and a stable arc. It is applicable for mild and stainless steel welding operations both with **rutile, basic, inox electrodes etc.**

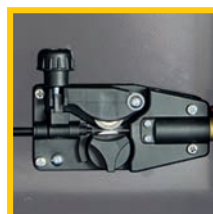

Trainafilo 2 rulli D.25mm
2 rolls wire feeder D.25mm

 MADE IN SAN MARINO		CE		MIGA 200	
Tensione di alimentazione - Input voltage		1 ph - 230V - 50/60 Hz			
Potenza assorbita - Absorbed power: 60% / Max		1,6 / 2,5 kW			
Fusibile - Fuse		16A			
Generatore - Generator		+/- 30% (4 kW)			
Rendimento - Efficiency		> 80%			
Campo di regolazione - Welding current		MIG - NO GAS	MMA		
		10 - 150A	10 - 130A		
Servizio - Duty cycle 40°C EN 60974-1		110A - 25%	100A - 25%		
		70A - 60%	60A - 60%		
Tensione a vuoto - Open circuit voltage		100V			
MIG - NO GAS Filo ø mm Wire ø mm	Acciaio - Steel	0,6 - 0,8 - 0,9			
	Inox - Stainless steel	0,8			
	Al.Mg / Al.Si	0,8 - 1,0			
	Cu.Si 3 / Cu.Al 8	0,8			
	Filo animato - Flux cored	0,8 - 0,9 - 1,0			
Bobina ø mm - Wire spool ø mm		100			
MMA Elettrodi: ø mm Electrodes: ø mm	Rutile / Basico Rutile / Basic	1,6 - 3,2			
Connessioni in uscita - Output connection		Torcia fissa / Direct torch DX 25 mmq			
Protezione termostatica - Thermostatic Protection		•			
Peso - Weight ≈		7,6 kg			
Dimensioni - Dimensions		367 x 166 x 337 mm			
Codice - Code		230000			

Accessori in dotazione - Supplied accessories:

Funzioni MIG

- Easy Mig Full Setting: tabella di aiuto per la corretta impostazione dei parametri di saldatura.
- Velocità del filo e tensione d'arco regolabili autonomamente.
- Induttanza elettronica automatica: riduce gli spruzzi durante la saldatura e stabilizza l'arco.
- Hot Start: migliora l'accensione dell'arco. Molto utile nella saldatura dell'alluminio.
- Burn back: evita l'incollaggio del filo al pezzo a fine saldatura.

Funzioni MMA

- Hot Start.
- Arc Force.
- Anti-sticking.

MIG Features

- Easy Mig Full Setting: help table for the correct adjustment of the welding parameters.
- Adjustable welding wire speed and voltage
- Automatic electronic inductance: it reduces spattering and stabilizes welding arc.
- Hot Start: it improves arc ignition. Useful for aluminum welding.
- Burn back: it avoids wire sticking on work piece.

MMA Features

- Hot Start.
- Arc Force.
- Anti-sticking.

Accessori - Accessories MIG / MAG pag.104

Optional and Consumable							
■ Animato / Flux 0,9 0,7kg 010818 ■ (Fe) Acciaio / Steel 0,6 0,7kg 010871 0,8 0,8kg 010872 ■ Inox / Stainless steel 0,8 0,7kg 010892 ■ (AlMg) Alluminio 0,8 0,4kg 010881 1,0 0,4kg 010882 ■ (AlSi) Alluminio 1,0 0,5kg 010844		Kit attacco bombola non ricaricabile Kit Adapter not refillable bottle ■ ■ 010810 Regolatore di pressione Pressure regulator (M10) ■ ■ 010515		Elettrodi / Electrodes Rutile 2,0mm 40pc 010221 2,5mm 30pc 010222 Inox /Stainless steel 2,0mm 40pc 010128 2,5mm 30pc 010129		WM24 DIN 11 Filtro auto-oscurante 90x34mm Auto-darkening filter 90x34mm	
Rullino trainafilo Wire roller ■ Fe 0,8/1,0 011251 ■ Al 0,8/1,0/1,2 011252		Bombole non ricaricabili Not refillable bottles (M10) ■ Argon/CO2 1L 010502 ■ Argon 1L 010503		Pinza porta elettrodo Electrode holder 160A + 1,7m 16mmq + DX25 010060		Guanti (T10) Gloves (S10)	
Ugello porta corrente Contact tip ■ Fe 0,6 3pc 010253 ■ Fe 0,8 3pc 010254 ■ Fe 1,0 3pc 010255 ■ Al 0,8 3pc 010256 ■ Al 1,0 3pc 010257				Posizionatore Position holder (1) MPH 92 010346 (2) MPH 62 010345		Grembiule in crosta Crust leather apron (Tg / Size L)	

MADE IN SAN MARINO		CE		MIGA 215	MIGA 218	MIGA 220	
Tensione di alimentazione - Input voltage		1 ph - 230V - 50/60 Hz					
Potenza assorbita - Absorbed power: 60% / Max		1,6 / 2,5 kW		2,2 / 3,5 kW		2,8 / 5 kW	
Fusibile - Fuse		16A		16A		16A	
Generatore - Generator		+/- 30% (4 kW)		+/- 30% (4 kW)		+/- 30% (4,5 kW)	
Rendimento - Efficiency		> 80%		> 80%		> 80%	
Campo di regolazione - Welding current		MIG / TIG	MMA	MIG / TIG	MMA	MIG / TIG	MMA
Servizio - Duty cycle 40°C EN 60974-1		110A - 25%	100A - 25%	140A - 25%	120A - 25%	180A - 25%	150A - 25%
Tensione a vuoto - Open circuit voltage		100V		86V		86V	
MIG - NO GAS Filo ø mm Wire ø mm	Acciaio - Steel	0,6 - 0,8 - 0,9		0,6 - 0,8 - 0,9		0,6 - 0,8 - 0,9 - 1,0	
	Inox - Stainless steel	0,8		0,8		0,8 - 1,0	
	Al.Mg / Al.Si	0,8 - 1,0		0,8 - 1,0		0,8 - 1,0 - 1,2	
	Cu.Si 3 / Cu.Al 8	0,8		0,8		0,8 - 1,0	
	Filo animato - Flux cored	0,8 - 0,9 - 1,0		0,8 - 0,9 - 1,0 - 1,2		0,8 - 0,9 - 1,0 - 1,2	
Bobina ø mm - Wire spool ø mm		100 - 200		100 - 200		100 - 200	
MMA / TIG Elettrodi : ø mm Electrodes: ø mm	Rutile / Basico Rutile / Basic	1,6 - 3,2		1,6 - 3,2		1,6 - 4,0	
	TIG	1,0 - 2,4		1,0 - 4,0		1,0 - 4,0	
Connessioni in uscita - Output connection		Torchia fissa / Direct torch DX 25 mmq		Torch Euro DX 25 mmq		Torch Euro DX 25 mmq	
Protezione temostatica - Thermostatic Protection		●		●		●	
Peso - Weight ≈		9,5 kg		9,5 kg		10,0 kg	
Dimensioni - Dimensions		452 x 220 x 345 mm		452 x 220 x 345 mm		452 x 220 x 345 mm	
Codice - Code		241800		241900		242000	

MIGA 215: accessori in dotazione - Supplied accessories:

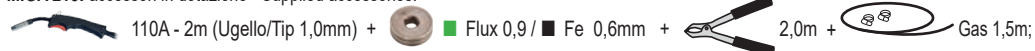

MIGA 218 - 220: accessori in dotazione - Supplied accessories:



Accessori - Accessories MIG / MAG pag.104

Optional and Consumable							
Animato / Flux 0,9 0,7kg 010818 (Fe) Acciaio / Steel 0,6 0,7kg 010871 0,8 0,8kg 010872 Inox / Stainless steel 0,8 0,7kg 010892 (AlMg) Alluminio 0,8 0,4kg 010881 1,0 0,4kg 010882 (AlSi) Alluminio 1,0 0,5kg 010844		Guaina per torchia Torch liner Al 0,6/0,9 010746 Al 1,0/1,2 010747	MIGA 218 MIGA 220 	Regolatore di pressione + adattatore CO2 <=> Ar (IT / USA) Pressure regulator + adapter CO2 <=> Ar (IT / USA) 010832		Pinza porta elettrodo Electrode holder 200A + 2,7m 16mmq + DX25 010069	
Rullino trainafilo Wire roller Fe 0,8/1,0 011251 Fe 0,6 Flux 0,9 011250 Al 0,8/1,0/1,2 011252		Kit attacco bombola non ricaricabile Kit Adapter not refillable bottle 010810		Torchia TIG / TIG Torch TG17 140A - 4m Dx25/50mmq (1,6 WR2 acciaio-steel) 010068		Posizionatore Position holder (1) MPH 92 010346 (2) MPH 62 010345	 92mm 58mm (1) (2)
Ugello porta corrente Contact tip Fe 0,6 3pc 010253 Fe 0,8 3pc 010254 Fe 1,0 3pc 010255 Al 0,8 3pc 010256 Al 1,0 3pc 010257		Regolatore di pressione Pressure regulator (M10) 010515		Bacchette TIG / TIG rods L. 330mm Kg 0,33 Inox 308L 011264 1,6mm		Guanti (T10) Gloves (S10) 010963	
		Bombole non ricaricabili Not refillable bottles (M10) Argon/CO2 1L 010502 Argon 1L 010503		CRMI Carrello / Trolley 010823		WM24 DIN 11 Filtro auto-oscurante 90x34mm Auto-darkening filter 90x34mm 010402	

Funzioni MIG

- Saldatura sinergica assistita.
- Induttanza elettronica regolabile.
- Hot Start.
- Burn back.

Funzioni MMA

- Hot Start.
- Arc Force regolabile.
- Anti-sticking.

Funzioni TIG

- TIG innesco LIFT (Torchia con rubinetto).
- Anti-sticking.
- Slope down regolabile.

MIG Features

- Assisted synergetic welding.
- Adjustable electronic inductance.
- Hot Start.
- Burn back.

MMA Features

- Hot Start.
- Adjustable Arc Force.
- Anti-sticking.

TIG Features

- TIG with LIFT arc striking (Torch with manual gas valve).
- Anti-sticking.
- Adjustable Slope down.

MIGA 225XL

MULTIPROCESS MIG / MAG - NO GAS - MMA - TIG INVERTER

Manutenzione
Maintenance
Carpenteria leggera
Light carpentry
Autoriparazioni
Automotive



15 kg MAX

SPECIALE GENERATORE
GENERATOR USE

MIGA 225XL è una saldatrice inverter MIG/MAG e NO GAS, MMA e TIG trasportabile. È la saldatrice ideale per l'artigiano professionista che ha bisogno di vari processi di saldatura per interventi all'aperto e al chiuso. La macchina alloggia bobine di filo di diametro 300/200mm come le saldatrici adatte all'uso professionale.

- **CONTROLLO MIG SINERGICO:** In modalità saldatura MIG sinergica il microprocessore che controlla la macchina provvede a regolare l'induttanza e gli altri parametri di saldatura. Basta selezionare il programma indicato nella tabella di aiuto e si è subito pronti a saldare.
- **MIGA 225XL** unisce semplicità e compattezza a caratteristiche uniche nel suo segmento come la possibilità di regolare l'**INDUTTANZA** nella saldatura MIG per ridurre gli spruzzi; l'**ARC FORCE** in MMA per ridurre il rischio d'incollare l'elettrodo al pezzo da saldare; la **RAMPA DI DISCESA** in TIG per agevolare la chiusura del cordone di saldatura.
- Il **cambio di polarità** per saldare con filo animato (NO GAS) rende la saldatura in esterno più semplice. Il filo animato contiene al suo interno una sostanza che crea la protezione gassosa e quindi non richiede la bombola del gas.
- **MIGA 225XL** è l'ideale per operare su acciaio, inox, alluminio e saldobrasatura MIG per acciaio zincato.
- È anche un'ottima saldatrice **TIG DC LIFT** e **MMA** con eccellenti proprietà d'innesco ed un arco stabile. È indicata per le operazioni di saldatura ad elettrodo di acciaio dolce e inox con elettrodi rutili, basici, inox, ecc.

MIGA 225XL is a transportable MIG/MAG and NO GAS, MMA and TIG inverter welding machine. It is the ideal choice for the professional craftsman, who needs different welding processes for operations indoors as well as outdoors. The machine can accommodate a 300/200mm wires spool like professional welders.

- **MIG SYNERGIC CONTROL:** in the MIG synergic welding mode the microprocessor that controls the machine regulates the inductance and other welding parameters. By just selecting the program shown in the help table the machine is immediately ready to weld.
- **MIGA 225XL** combines simplicity and compactness with unique features in its segment such as the ability to adjust **INDUCTANCE** in MIG welding to reduce spatters. **ARC FORCE** in MMA to reduce the risk of the electrode sticking to the weld pool and **SLOPE DOWN** in TIG to facilitate the end of the welding bead.
- **Reversed polarity** for welding with innershield wire (NO GAS) is a standard feature that makes outdoor welding less complicated. The innershield wire is comprised of welding material and flux that create its own gas shield. This means no need for a gas cylinder.
- **MIGA 225XL** is ideal to operate on steel, stainless steel and aluminum and MIG braze-welding for galvanized steel.
- It is also an excellent **TIG DC LIFT** and **MMA** welding machine and with excellent ignition properties and a stable arc. It is suitable for mild and stainless steel welding operations with rutile, basic, inox electrodes.

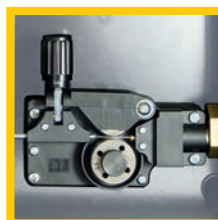
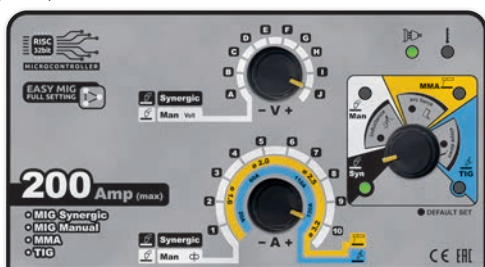

Trainafilo 2 rulli D.30mm
2 rolls wire feeder D.30mm

MADE IN SAN MARINO		CE		MIGA 225XL	
Tensione di alimentazione - Input voltage		1 ph - 230V - 50/60 Hz			
Potenza assorbita - Absorbed power: 60% / Max		2,8 / 4,5 kW			
Fusibile - Fuse		16A			
Generatore - Generator		+/- 30% (7 kW)			
Rendimento - Efficiency		>80%			
Campo di regolazione - Welding current range		MIG / TIG	MMA		
		10 - 200A	10 - 160A		
Servizio - Duty cycle 40°C EN 60974-1		180A - 25%	150A - 25%		
		100A - 60%	100A - 60%		
Tensione a vuoto - Open circuit voltage		86V			
MIG - NO GAS Filo ø mm Wire ø mm	Acciaio - Steel	0,6 - 0,8 - 0,9 - 1,0			
	Inox	0,8 - 1,0			
	Al.Mg / Al.Si	0,8 - 1,0 - 1,2			
	Cu.Si 3 / Cu.Al 8	0,8 - 1,0			
	Filo animato - Flux cored	0,8 - 0,9 - 1,0 - 1,2			
Bobina ø mm- Wire spool ø mm		200 - 300			
MMA / TIG Elettrodi : ø mm Electrodes: ø mm	Rutile / Basico Rutile / Basic	1,6 - 4,0			
	TIG	1,0 - 4,0			
Protezione temostatica - Thermostatic Protection		•			
Peso - Weight =		14,6 kg			
Dimensioni - Dimensions		555 x 276 x 425 mm			
Codice - Code		242100			

Accessori in dotazione - Supplied accessories:



Funzioni MIG

- Saldatura sinergica assistita.
- Induttanza elettronica regolabile.
- Hot Start.
- Burn back.

Funzioni MMA

- Hot Start.
- Arc Force regolabile.
- Anti-sticking.

Funzioni TIG

- TIG innesco LIFT (Torch con rubinetto).
- Anti-sticking.
- Slope down regolabile.

MIG Features

- Assisted synergic welding.
- Adjustable electronic inductance.
- Hot Start.
- Burn back.

MMA Features

- Hot Start.
- Adjustable Arc Force.
- Anti-sticking.

TIG Features

- TIG with LIFT arc striking (Torch with manual gas valve).
- Anti-sticking.
- Adjustable Slope down.

Accessori - Accessories MIG / MAG pag.104

Optional and Consumable						
Animato / Flux 0,9 2,0kg 010816 (Fe) Acciaio / Steel 0,6 5,0kg 010801 0,8 5,0kg 010805 1,0 5,0kg 010846 (AlMg) Alluminio 1,0 2,0kg 010876 (AlSi) Alluminio 1,0 2,0kg 010860 (CuSi3) Brazing 0,8 2,0kg 010845		Guaina per torcia Torch liner ■ Fe 0,6/0,9 010743 ■ Fe 1,0/1,2 010744 ■ Al 0,6/0,9 010746 ■ Al - CuSi3 1,0/1,2 010747		Bacchette TIG / TIG rods L. 1000mm Kg 1,0 Inox 308L 1,6mm 011255 Inox 316L 1,6mm 011256 Inox 309L 1,6mm 011257	WM27 DIN 9-13 Filtro auto-oscurante 93x43mm Auto-darkening filter 93x43mm 010404	
Rullino trainafilo Wire roller ■ Flux 0,9/1,0 011218 ■ Flux 1,0/1,2 011219 ■ Fe 1,0/1,2 011215 ■ Al 0,8/1,0 011216 ■ Al 1,0/1,2 011217		Regolatore di pressione + adattatore CO2 <-> Ar (IT / USA) Pressure regulator + adapter CO2 <-> Ar (IT / USA) ■ ■ ■ 010832		Torcia TIG / TIG Torch TG17 140A - 4m Dx25/50mmq (1,6 WR2 acciaio-steel) 010068	Guanti (T10) Gloves (S10) 010963	
Ugello porta corrente Contact tip ■ Fe 0,6 3pc 010253 ■ Fe 0,8 3pc 010254 ■ Fe 1,0 3pc 010255 ■ Al 0,8 3pc 010256 ■ Al 1,0 3pc 010257		Posizionatore Position holder (1) MPH 92 010346 (2) MPH 62 010345		CRMI Carrello / Trolley 010823	Pinza porta elettrodo Electrode holder 200A + 2,7m 16mmq + DX25 010069	

MIGA Moving

MULTIPROCESS MIG / MAG - NO GAS - MMA - TIG INVERTER

MODEL 2023

Manutenzione
Maintenance
Carpenteria leggera
Light carpentry
Autoriparazioni
Automotive

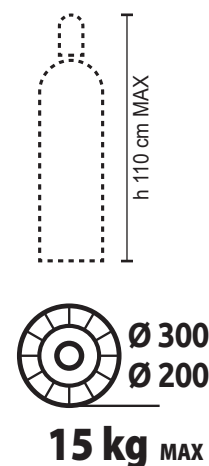

MIGA
SPECIALE GENERATORE
GENERATOR USE

I modelli MIGA carrellati per bobine di filo di diametro 300/200mm sono saldatrici inverter monofase per saldature MIG/MAG, NO GAS, MMA e TIG. Sono l'ideale per l'artigiano ed il professionista che ha bisogno di vari processi di saldatura.

- **CONTROLLO MIG SINERGICO:** In modalità saldatura MIG sinergica il microprocessore che controlla la macchina provvede a regolare l'induttanza e gli altri parametri di saldatura. Basta selezionare il programma indicato nella tabella di aiuto e si è subito pronti a saldare.
- La serie **MIGA 3** unisce semplicità e compattezza a caratteristiche uniche nel suo segmento come la possibilità di regolare l'**INDUTTANZA** nella saldatura MIG per ridurre gli spruzzi; l'**ARC FORCE** in MMA per ridurre il rischio d'incollare l'elettrodo al pezzo da saldare; la **RAMPA DI DISCESA** in TIG per agevolare la chiusura del cordone di saldatura.
- Il **cambio di polarità** per saldare con filo animato (NO GAS) rende la saldatura in esterno più semplice. Il filo animato contiene al suo interno una sostanza che crea la protezione gassosa e quindi non richiede la bombola del gas.
- Sono l'ideale per operare su acciaio, inox, alluminio e saldobrasatura MIG per acciaio zincato.
- Sono anche delle ottime saldatrici **TIG DC LIFT** e **MMA** con eccellenti proprietà d'innesco ed un arco stabile. Sono indicate per le operazioni di saldatura ad elettrodo di acciaio dolce e inox con elettrodi rutili, basici, inox, ecc.

MIGA 3 series with 300/200mm wire spool are wheeled single-phase inverter welding machines for MIG/MAG, NO GAS, MMA and TIG welding operations. It is the ideal welding machine for the professional craftsman, who needs different welding processes.

- **MIG SYNERGIC CONTROL:** in the MIG synergic welding mode the microprocessor that controls the machine regulates the inductance and other welding parameters. By just selecting the program shown in the help table and the machine is immediately ready to weld.
- **MIGA 3** combines simplicity and compactness with unique features in its segment such as the ability to adjust **INDUCTANCE** in MIG welding to reduce spatters. **ARC FORCE** in MMA to reduce the risk of the electrode sticking to the weld pool and **SLOPE DOWN** in TIG to facilitate the end of the welding bead.
- **Reversed polarity** for welding with innershield wire (NO GAS) is a standard feature that makes outdoor welding less complicated. The innershield wire is comprised of welding material and flux that create its own gas shield. This means no need for a gas cylinder.
- **MIGA 3** are ideal to operate on steel, stainless steel and aluminum and MIG braze-welding for galvanized steel.
- They are also excellent **TIG DC LIFT** and **MMA** welding machines with excellent ignition properties and a stable arc. They are suitable for mild and stainless steel welding operations with rutile, basic, inox electrodes, etc.

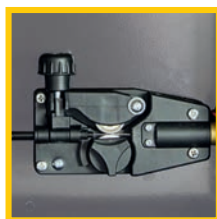

MIGA 320:
Trainafilo 2 rulli D.25mm
2 rolls wire feeder D.25mm

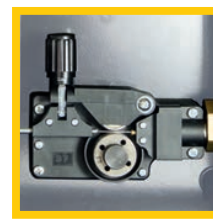
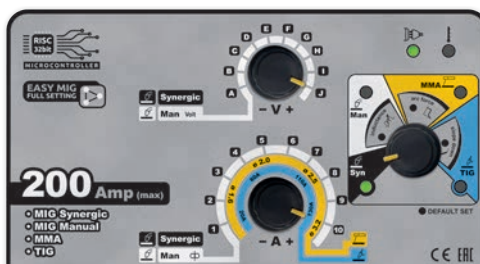

MIGA 380:
Trainafilo 2 rulli D.30mm
2 rolls wire feeder D.30mm

		CE		MIGA 320	MIGA 380
Tensione di alimentazione - Input voltage		1 ph - 230V - 50/60 Hz		1 ph - 230V - 50/60 Hz	
Potenza assorbita - Absorbed power: 60% / Max		2,8 / 4,5 kW		2,8 / 4,5 kW	
Fusibile - Fuse		16A		16A	
Generatore - Generator		+/- 30% (7 kW)		+/- 30% (7 kW)	
Rendimento - Efficiency		>80%		>80%	
Campo di regolazione - Welding current range		MIG / TIG	MMA	MIG / TIG	MMA
Servizio - Duty cycle 40°C EN 60974-1		10 - 200A	10 - 160A	10 - 200A	10 - 160A
		180A - 25%	150A - 25%	180A - 25%	150A - 25%
Tensione a vuoto - Open circuit voltage		100A - 60%	100A - 60%	100A - 60%	100A - 60%
		86V		86V	
MIG - NO GAS Filo ø mm Wire ø mm	Acciaio - Steel	0,6 - 0,8 - 0,9 - 1,0		0,6 - 0,8 - 0,9 - 1,0	
	Inox	0,8 - 1,0		0,8 - 1,0	
	Al.Mg / Al.Si	0,8 - 1,0 - 1,2		0,8 - 1,0 - 1,2	
	Cu.Si 3 / Cu.Al 8	0,8 - 1,0		0,8 - 1,0	
	Filo animato - Flux cored	0,8 - 0,9 - 1,0 - 1,2		0,8 - 0,9 - 1,0 - 1,2	
Bobina ø mm- Wire spool ø mm		100 - 200		200 - 300	
MMA - TIG Elettrodi: ø mm Electrodes: ø mm	Rutile / Basico Rutile / Basic	1,6 - 4,0		1,6 - 4,0	
	TIG	1,0 - 4,0		1,0 - 4,0	
	Protezione temostatica - Thermostatic Protection	●		●	
Peso - Weight =		15 kg		30 kg	
Dimensioni - Dimensions		701 x 360 x 516 mm		775 x 400 x 790 mm	
Codice - Code		242400		242800	

MIGA 320: accessori in dotazione - supplied accessories:



MIGA 380: accessori in dotazione - supplied accessories:



Accessori - Accessories MIG / MAG pag.104

Optional and Consumable							
<ul style="list-style-type: none"> Animato / Flux 0,9 2,0kg 010816 (Fe) Acciaio / Steel 0,6 5,0kg 010801 0,8 5,0kg 010805 1,0 5,0kg 010846 (AlMg) Alluminio 1,0 2,0kg 010876 (AlSi) Alluminio 1,0 2,0kg 010860 (CuSi3) Brazing 0,8 2,0kg 010845 		Guaina per torcia Torch liner <ul style="list-style-type: none"> Fe 0,6/0,9 010743 Al 0,6/0,9 010746 Al - CuSi3 1,0/1,2 010747 		Bacchette TIG / TIG rods L. 1000mm Kg 1,0 <ul style="list-style-type: none"> Inox 308L 1,6mm 011255 Inox 316L 1,6mm 011256 Inox 309L 1,6mm 011257 		Posizionatore Position holder (1) MPH 92 010346 (2) MPH 62 010345	
Rullino trainafilo Wire roller <ul style="list-style-type: none"> Flux 0,9 / Fe 0,6 011250 Al 0,8/1,0/1,2 011252 		Ugello porta corrente Contact tip <ul style="list-style-type: none"> Fe 0,6 3pc 010253 Fe 0,8 3pc 010254 Fe 1,0 3pc 010255 Al 0,8 3pc 010256 Al 1,0 3pc 010257 		Torcia TIG / TIG Torch TG17 140A - 4m Dx25/50mmq (1,6 WR2 acciaio-steel) 010068		Pinza porta elettrodo Electrode holder 200A + 2,7m 16mmq + DX25 010069	
Rullino trainafilo Wire roller <ul style="list-style-type: none"> Flux 0,9/1,0 011218 Flux 1,0/1,2 011219 Fe 1,0/1,2 011215 Al 0,8/1,0 011216 Al 1,0/1,2 011217 		Regolatore di pressione + adattatore CO2 <-> Ar (IT / USA) Pressure regulator + adapter CO2 <-> Ar (IT / USA) 010832		Grembiule in crosta Crust leather apron (Tg / Size L) 010847		WM27 DIN 9-13 Filtro auto-oscurante 93x43mm Auto-darkening filter 93x43mm 010404	

Funzioni MIG

- Saldatura sinergica assistita.
- Induttanza elettronica regolabile.
- Hot Start.
- Burn back.

Funzioni MMA

- Hot Start.
- Arc Force regolabile.
- Anti-sticking.

Funzioni TIG

- TIG innesco LIFT (Torcia con rubinetto).
- Anti-sticking.
- Slope down regolabile.

MIG Features

- Assisted synergic welding.
- Adjustable electronic inductance.
- Hot Start.
- Burn back.

MMA Features

- Hot Start.
- Adjustable Arc Force.
- Anti-sticking.

TIG Features

- TIG with LIFT arc striking (Torch with manual gas valve).
- Anti-sticking.
- Adjustable Slope down.

i-PAC 340-335K

PAC INVERTER

Manutenzione
Maintenance
Carpenteria leggera
Light carpentry
Autoriparazioni
Automotive



INCLUDED!

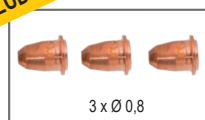

i-PAC 340

8 mm taglio - cut
12mm separazione - severance

SPECIALE GENERATORE
GENERATOR USE

i-PAC 335K

6 mm taglio - cut
12mm separazione - severance

COMPRESSORE INTEGRATO
COMPRESSOR INSIDE

SPECIALE GENERATORE
GENERATOR USE

- **Taglio al plasma inverter monofase per il taglio manuale su acciaio, alluminio e acciaio inox.**
- L'arco di taglio è acceso automaticamente per mezzo dell'arco pilota. Questo garantisce una maggiore vita dei consumabili della torcia.
- Il taglio su lamiere perforate è reso possibile dalla tecnologia che commuta dall'arco pilota all'arco di taglio.
- Le macchine tagliano spessori fino a 8mm (i-PAC 340) e 6mm (i-PAC 335K) con un'ottima qualità. Se non ci sono particolari esigenze di qualità le macchine separano fino a 12mm di spessore.

- **Single-phase inverter Plasma cutter for manual cutting on mild steel, aluminum and stainless steel.**
- The plasma arc is ignited automatically via the pilot arc. This means longer service life of wear parts in the torch body.
- Cutting on perforated plates is possible due to the advanced technology that makes the machine switch between cutting arc and pilot arc.
- The machine handles plates up to 8mm (i-PAC 340) and 6mm (i-PAC 335K) with a quality cut. If there are no special demands about the quality of the cut surface, the severance is up to 12mm.



i-PAC 340

- Regolazione aria integrata
- Integrated air pressure control

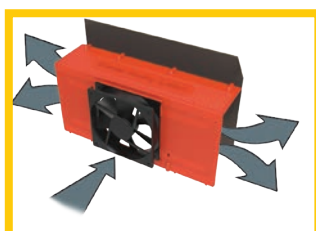

i-PAC 340

- Ventilazione ad alte prestazioni
- High performance air cooling



i-PAC 340 / 335K

- Taglio di alta qualità
- High quality cut

MADE IN SAN MARINO		CE	
		i-PAC 340	i-PAC 335K
Tensione di alimentazione - Input voltage		1 ph - 230V - 50/60 Hz	
Potenza assorbita - Absorbed power: 60% / Max		2,7 / 3,9 kW	2,7 / 3,9 kW
Fusibile - Fuse		16A	16A
Generatore - Generator		+/- 30% (6kW)	+/- 30% (6kW)
Rendimento - Efficiency		> 80%	> 80%
Corrente di taglio - Cutting current		5 - 35A	5 - 35A
Servizio 40°C - Duty cycle 40°C EN 60974-1		35A - 30%	35A - 30%
		25A - 60%	25A - 60%
		20A - 100%	20A - 100%
Tensione a vuoto - Open circuit voltage		410V	410V
Taglio / Separazione - Cut / Separation		8 / 12 mm	6 / 12 mm
Pressione aria min/max - Air pressure min/max		3,5 - 5,0 bar	-
Consumo aria - Air consumption		115 lt/min	
Compressore integrato - Built in Compressor		-	•
Connettore torcia - Torch connection		Diretto - Direct	Diretto - Direct
Connettore massa - Earth connection		DX 25 mmq	DX 25 mmq
Peso - Weight ≈		6,7 kg	16 kg
Dimensioni - Dimensions		480 x 160 x 273 mm	480 x 227 x 373 mm
Codice - Code		111000	115100

Caratteristiche

- Innesco con arco pilota.
- Taglio manuale.
- Taglio su grigliato.
- Torcia con cavo da 4m.
- Ventilazione ad alta efficienza.
- Allerta alimentazione elettrica.
- Allerta protezione termostatica.
- Sistema di sicurezza torcia.
- Alimentazione da rete o da generatore.

Features

- Arc striking with pilot arc.
- Manual cutting.
- Cut on grid.
- 4m lenght cable torch.
- High efficiency air cooling.
- Power indicator.
- Thermostatical protection indicator.
- Torch safety system.
- Power supply from mains or generator.

i-PAC 340: Accessori in dotazione - Supplied accessories

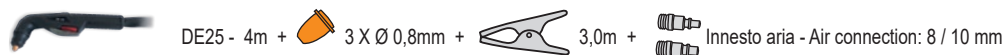

i-PAC 335K: Accessori in dotazione - Supplied accessories



Accessori - Accessories PAC pag.110

Consumabili torcia / Torch consumables			
DE25 (i-PAC 340)			
(a)	Porta ugello 6 fori - Nozzle holder 6 holes	010186	4 pcs
(b)	Ugello-Nozzle ø 0,6 mm 20A	010961	10 pcs
(b)	Ugello-Nozzle ø 0,8 mm 30A	010183	10 pcs
(c)	Diffusore aria-Swirl	010179	2 pcs
(d)	Elettrodo-Electrode	010180	10 pcs
DE25K (i-PAC 335K)			
(a)	Porta ugello 4 fori - Nozzle holder 4 holes	010198	4 pcs
(b)	Ugello-Nozzle ø 0,6 mm 20A	010961	10 pcs
(b)	Ugello-Nozzle ø 0,8 mm 30A	010183	10 pcs
(c)	Diffusore aria-Swirl	010179	2 pcs
(d)	Elettrodo-Electrode	010180	10 pcs

Optional and Consumable			
Starter kit 010082	CR28 Carrello / Trolley 010889		
WM31 TC True Colour / Grinding DIN 9-13 Filtro auto-oscurante a colori reali 93x43mm True colour auto-darkening filter 93x43mm 010408	Guanti (T10) Gloves (S10) 010963		
	Grembiule in crosta Crust leather apron (Tg / Size L) 010847		

MMA TRADITIONAL



Utilizzo leggero
Light duty
Carpenteria leggera
Light carpentry
Cantiere edile
Construction site

- Robuste e durevoli
- Carrozzeria resistente
- Elettrodi rutili
- Sturdy and durable
- Tough housing
- Rutile electrodes

MADE IN SAN MARINO



	GLOBUS 3.0	GLOBUS 4.0	GLOBUS 5.0 D
Tensione di alimentazione - Input voltage	1 ph - 230V 50/60 Hz	1 ph - 230V 50/60 Hz	1 ph - 230/400V 50/60 Hz
Potenza assorbita - Absorbed power: Min / Max	2,0 - 4,0 kW	2,0 - 5,0 kW	2,0 - 6,0 kW
Fusibile - Fuse	16A	20A	25/20A
	MMA AC	MMA AC	MMA AC
Campo di regolazione - Welding current	44 - 140A	44 - 160A	30 - 200A
Tensione a vuoto - Open circuit voltage	43 - 49V		41 - 50V
MMA Elettrodi : \varnothing mm Electrodes: \varnothing mm	Rutile 1,6 - 3,2	1,6 - 4,0	1,6 - 5,0
Connessioni in uscita - Output connection	Cavi diretti - Direct cables		DX 25 mmq
Ventilata - Fan cooled	•	•	•
Protezione termostatica - Thermostatic Protection	•	•	•
Peso - Weight ≈	13,9 kg	15,6 kg	19,7 kg
Dimensioni - Dimensions	380 x 208 x 280 mm		570 x 320 x 350 mm
Codice - Code	204500	204700	203700

GLOBUS 3.0 e 4.0 Accessori in dotazione - Supplied accessories



Accessori - Accessories MMA pag.99

Optional

Kit saldatura / Welding kit
(GLOBUS 5.0)
DS16 180A 3+2m 16mmq 25

000201



Globus 4.0
Kit ruote per Globus 4.0
wheels kit

010272



D-mig 230 AC - 235

MIG / MAG - NO GAS TRADITIONAL

Utilizzo leggero
Light duty
Manutenzione
Maintenance
Carpenteria leggera
Light carpentry

27

MMA - MIG / MAG TRADITIONAL



NO GAS
 Ø 100
1 kg MAX

**MIG/MAG
NO GAS**
 Ø 200
Ø 100
5 kg MAX



MADE IN SAN MARINO



		D-mig 230 AC	D-mig 235
Tensione di alimentazione - Input voltage		1 ph - 230V 50/60 Hz	
Potenza assorbita - Absorbed power: 60% / Max		Min. 1,0 / Max 1,8 kW	1,4 / 3,3 kW
Fusibile - Fuse		16A	16A
Rendimento - Efficiency		> 80%	< 80%
		NO GAS	MIG-MAG / NO GAS
Campo di regolazione - Welding current range		90 - 130A	32 - 120A
Posizioni di saldatura - Welding positions		2	4
Servizio 40° C - Duty cycle 40° C EN 60974-1		80A - 20%	100A - 15%
		40A - 90%	55A - 60%
Tensione a vuoto - Open circuit voltage		18 - 22V	31 - 49V
MIG - NO GAS Filo ø mm Wire ø mm	Acciaio - Steel	-	0,6 - 0,8
	Inox	-	0,8
	Al.Mg - Al.Si	-	0,8 - 1,0
	Filo animato - Flux cored	0,9	0,9
Bobina Ø mm - Wire spool Ø mm		100	100 - 200
Ventilata - Fan cooled			•
Peso - Weight ≈		13,3 kg	20,5 kg
Dimensioni - Dimensions		330 x 185 x 320 mm	406 x 230 x 357 mm
Codice - Code		241300	241400

- Saldano MIG/MAG con gas e con filo animato senza gas.
- Il cambio di polarità per saldare con filo animato (NO GAS) è una caratteristica standard che rende la saldatura in esterno più semplice.
- Compatte e maneggevoli.
- Facili da usare: tabella di aiuto alla corretta regolazione dei parametri di saldatura.
- Trainafilo 2 rulli.
- Protezione termostatica.

- MIG/MAG welding with gas and flux cored welding wire without gas.
- Reversed polarity for welding with innershield wire (NO GAS) is a standard feature that makes outdoor welding less complicated.
- Compact and handy.
- Easy to use: help table for the correct adjustment of the welding parameters.
- 2 rolls wire feeder.
- Thermostatic protection.

Accessori in dotazione - Supplied accessories:



D-mig 380-420S

MIG / MAG - NO GAS TRADITIONAL



Utilizzo leggero
Light duty
Manutenzione
Maintenance
Carpenteria leggera
Light carpentry
Autoriparazioni
Automotive

D-mig 380 e 420S sono saldatrici tradizionali monofase per saldatura MIG/MAG e NO GAS. Le gamme classiche DECA per i piccoli lavori e per la manutenzione professionale su piccoli spessori.

- Facili da usare: tabella di aiuto alla corretta regolazione dei parametri di saldatura (D-mig 380).
- Il cambio di polarità per saldare con filo animato NO GAS (D-MIG 380) rende la saldatura in esterno più semplice. Il filo animato contiene al suo interno una sostanza che crea la protezione gassosa e quindi non richiede la bombola del gas.
- D-mig 380 e 420 S sono ideali per operare su acciaio, inox ed alluminio.

D-mig 380 and 420S are traditional single-phase welding machines for MIG/MAG and NO GAS welding operations. The DECA classic range for small works and professional maintenance on small thicknesses.

- Easy to use: help table for the correct adjustment of the welding parameters (D-mig 380).
- Reversed polarity for welding with innershield wire NO GAS (D-mig 380) makes outdoor welding less complicated. The innershield wire is comprised of welding material and flux that create its own gas shield. This means no need for a gas cylinder.
- D-mig 380 and 420 S are ideal to operate on steel, stainless steel and aluminum.

D-mig 380

—	⊗	⊙	mm								
				0,8	1,0	1,5	2,0	3,0	4,0	5,0	>5,0
Fe	Ar/Co ₂	⊙	⊕	2	2	3	4	5	6		
				5-7	7-9	7-9	8-10	8-10	8-10		
Fe	Ar/Co ₂	⊙	⊕	2	3	3	4	5	6	6	
				5-8	5-8	8-10	7-9	7-10	7-9	9-10	
Al	Argon	⊙	⊕			2	3	5	6		
						8-10	9-10	9-10	9-10	9-10	
Al	Argon	⊙	⊕			2	3	5	6		
						8-10	9-10	9-10	9-10	9-10	
Fe	X Flux	⊙	⊕	2	2	2	3	3	4	5	6
				4-6	5-8	6-9	5-8	7-10	5-8	8-10	8-10



MADE IN SAN MARINO



D-mig 380

D-mig 420S

Tensione di alimentazione - Input voltage		1 ph - 230V 50/60 Hz	
Potenza assorbita - Absorbed power: 60% / Max		1,5 / 3,1 kW	1,8 / 4,3 kW
Fusibile - Fuse		16A	16A
Campo di regolazione - Welding current range		MIG MAG / NO GAS	MIG MAG
Posizioni di saldatura - Welding positions		35 - 160A	35 - 200A
Servizio 40°C - Duty cycle 40°C EN 60974-1		6	6
Tensione a vuoto - Open circuit voltage		130A - 10%	165A - 15%
		65A - 60%	80A - 60%
Tensione a vuoto - Open circuit voltage		30 - 54V	29 - 52V
Filo ø mm Wires ø mm	Acciaio - Steel	0,6 - 0,8	0,6 - 0,8 - 1,0
	Inox	0,8	0,8
	Al.Mg - Al.Si	0,8 - 1,0	0,8 - 1,0
	Filo animato - Flux cored	0,9	-
Bobina Ø mm - Wire spool Ø mm		100 - 200	200 - 300
Trainafile - Wire feeder		2 rulli - 2 rollers	2 rulli - 2 rollers
Connessioni in uscita - Output connection		diretto - direct	Euro
Elettrovalvola gas - Gas solenoid valve		•	•
Protezione termostatica - Thermostatic Protection		•	•
Peso - Weight ≈		31,5 kg	41 kg
Dimensioni - Dimensions		760 x 360 x 490 mm	705 x 412 x 465 mm
Codice - Code		254500	255000

D-mig 380: Accessori in dotazione - Supplied accessories

160A - 2m (Ugello/Tip 1,0mm) + ■ Fe 0,6mm ■ Flux 0,8 / 0,9 / 1,2mm + 2,0m + Adattatore bombole - Bottle Adapter

D-mig 420 S : Accessori in dotazione - Supplied accessories

180A - 3 m (Ugello/Tip 0,8mm) + ■ Fe 0,6mm ■ Fe / Al 0,8 / 1,0mm + 2,0m + Gas 1,5m

Accessori - Accessories MIG / MAG pag.104

Optional and Consumable

<ul style="list-style-type: none"> ■ Animato / Flux 0,9 0,7kg 010818 ■ (Fe) Acciaio / Steel 0,6 0,7kg 010871 0,8 0,8kg 010872 ■ Inox / Stainless steel 0,8 0,7kg 010892 ■ (AlMg) Alluminio 0,8 0,4kg 010881 1,0 0,4kg 010882 ■ (AlSi) Alluminio 1,0 0,5kg 010844 		Rullino trainafile Wire roller ■ ■ Fe/Al 0,8/1,0 010673	D-mig 380 	Kit attacco bombola non ricaricabile Kit Adapter not refillable bottle ■ ■ 010810		Posizionatore Position holder (1) MPH 92 010346 (2) MPH 62 010345
<ul style="list-style-type: none"> ■ Animato / Flux 0,9 2,0kg 010816 ■ (Fe) Acciaio / Steel 0,6 5,0kg 010801 0,8 5,0kg 010805 1,0 5,0kg 010846 ■ (AlMg) Alluminio 1,0 2,0kg 010876 ■ (AlSi) Alluminio 1,0 2,0kg 010860 ■ (CuSi3) Brazing 0,8 2,0kg 010845 		Ugello porta corrente Contact tip ■ Fe 0,6 3pc 010253 ■ Fe 0,8 3pc 010254 ■ Fe 1,0 3pc 010255 ■ Al 0,8 3pc 010256 ■ Al 1,0 3pc 010257		Regolatore di pressione Pressure regulator (M10) ■ ■ 010515		Guanti (T10) Gloves (S10) 010963
<ul style="list-style-type: none"> ■ Animato / Flux 0,9 2,0kg 010816 ■ (Fe) Acciaio / Steel 0,6 5,0kg 010801 0,8 5,0kg 010805 1,0 5,0kg 010846 ■ (AlMg) Alluminio 1,0 2,0kg 010876 ■ (AlSi) Alluminio 1,0 2,0kg 010860 ■ (CuSi3) Brazing 0,8 2,0kg 010845 		Guaina per torcia Torch liner ■ Al 0,8/1,0 010370	D-mig 380 	Bombole non ricaricabili Not refillable bottles (M10) ■ Argon/CO2 1L 010502 ■ Argon 1L 010503		WM27 DIN 9-13 Filtro auto-oscurante 93x43mm Auto-darkening filter 93x43mm
<ul style="list-style-type: none"> ■ Animato / Flux 0,9 2,0kg 010816 ■ (Fe) Acciaio / Steel 0,6 5,0kg 010801 0,8 5,0kg 010805 1,0 5,0kg 010846 ■ (AlMg) Alluminio 1,0 2,0kg 010876 ■ (AlSi) Alluminio 1,0 2,0kg 010860 ■ (CuSi3) Brazing 0,8 2,0kg 010845 		Guaina per torcia Torch liner ■ Fe 0,6/0,9 010743 ■ Al 0,6/0,9 010746 ■ Al - CuSi3 1,0/1,2 010747	D-mig 420 S 	Regolatore di pressione + adattatore CO2 <-> Ar (IT / USA) Pressure regulator + adapter CO2 <-> Ar (IT / USA) ■ ■ ■ 010832		010404

Saldare per mestiere

Weld for work





**UNA SCELTA ESCLUSIVA
AN EXCLUSIVE CHOICE**

MMA INVERTER

MODEL 2023

Manutenzione
Maintenance

Carpenteria leggera
Light carpentry

Cantiere edile
Construction site



i-ARC
SPECIALE GENERATORE
GENERATOR USE

Saldatrici inverter MMA e TIG con innesco a striscio.
Maneggevoli e robuste. Il design ergonomico le rende perfette per il trasporto.

Le i-ARC 3 sono indicate sia per l'uso in officina che all'aperto: sono le macchine ideali per la manutenzione.

- Particolarmente adatte ad un uso con generatore.
- Una sola manopola le rende facili da usare.
- Le macchine offrono eccellenti proprietà d'innesco ed un arco stabile.
- Le i-ARC 3 sono indicate per le operazioni di saldatura su acciaio dolce e inox con elettrodi rutili, basici, inox, ecc.

Inverter MMA and TIG scratch arc striking welding machines.
Handy and sturdy welding machines. The lightweight and ergonomic design makes them perfect to bring along.

i-ARC 3 range is suitable for both workshop and outdoor use; they are the ideal machines for maintenance.

- Specifically suitable for use with engine generator.
- Only one knob: simple to operate.
- The machines have excellent ignition properties and a stable arc.
- i-ARC 3 are applicable for mild and stainless steel welding operations with rutile, basic, stainless steel electrodes, etc.



i-ARC 3 in versione completa di accessori
i-ARC 3 in full version of accessories

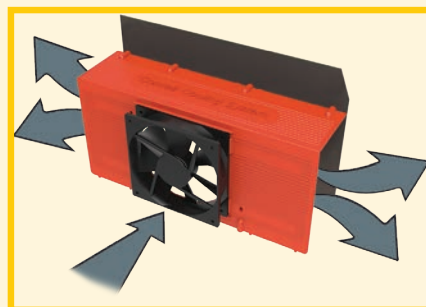

Ventilazione ad alte prestazioni
High performance air cooling



MADE IN SAN MARINO



i-ARC 318 LAB evo

i-ARC 320 LAB evo

Tensione di alimentazione - Input voltage		1 ph - 230V 50/60 Hz	
Potenza assorbita - Absorbed power: 60% / Max		3,3 / 5,4 kW	3,3 / 6,5 kW
Fusibile - Fuse		20A	20A
Generatore - Generator		+/- 30% (7 kW)	+/- 30% (8 kW)
Rendimento - Efficiency		> 80%	> 80%
Campo di regolazione - Welding current range		MMA DC	MMA DC
		10 - 180A	10 - 200A
Servizio DECA 20°C - DECA use 20°C		180A - 67%	200A - 60%
		160A - 80%	160A - 80%
Servizio 40°C - Duty cycle 40°C EN 60974-1		180A - 30%	200A - 30%
		125A - 60%	135A - 60%
Tensione a vuoto - Open circuit voltage		92V	92V
Elettrodi : ø mm Electrodes: ø mm	Rutile	1,6 - 4,0	1,6 - 5,0
	Basico - Basic	2,0 - 4,0	2,0 - 5,0
	TIG	1,0 - 4,0	1,0 - 4,0
Connessioni in uscita - Output connection		DX 25 mmq	DX 25 mmq
Protezione termostatica - Thermostatic Protection		•	•
Ventilata - Fan cooled		Convair Cooling System	Convair Cooling System
Peso - Weight ≈		5,2 kg	5,2 kg
Dimensioni - Dimensions		365 x 160 x 273 mm	
Versione - Version			
Solo generatore - Power source only		287000	287100
*Generatore + accessori *Power source + accessories		287080	287180

*Accessori in dotazione - Supplied accessories:

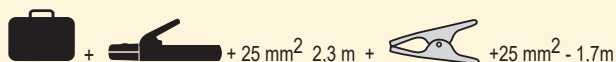
**Caratteristiche**

- Alimentazione da rete o da moto generatore.
- Indicazione macchina alimentata.
- Indicazione protezione termostatica.
- Ventilazione ad alta efficienza.

Funzioni MMA

- **Hot Start:** Eroga ampere aggiuntivi per i primi secondi quando si innesca l'arco. Aiuta ad ottenere la giusta temperatura del bagno di saldatura.
- **Arc Force:** Riduce il rischio d'incollare l'elettrodo al pezzo da saldare.
- **Anti-sticking:** Nel caso in cui l'elettrodo si incollò al pezzo da saldare, la corrente di saldatura è ridotta a pochi ampere per rendere più facile il distacco dell'elettrodo.

Funzioni TIG.

- **TIG DC:** Torcia con rubinetto ed innesco a striscio.

Features

- Power supply from the mains or from motor generator.
- Power indicator.
- Thermostatical protection indicator.
- High efficiency air cooling.

MMA Features

- **Hot Start:** It provides extra amps for the first seconds when igniting the arc. It helps create the right temperature in the weld pool.
- **Arc Force:** It reduces the risk of the electrode sticking to the weld pool.
- **Anti-sticking:** In case the electrode sticks to the weld pool, the welding current will decrease to few amps, making it easy to break off the electrode.

TIG Features

- **TIG DC:** Torch with gas valve and scratch arc striking.

Accessori - Accessories MMA pag.99

Optional and Consumables						
Pinza porta elettrodo Electrode holder 200A + 2,7m 25mmq + DX25 010834		Elettrodi / Electrodes Rutile E6013 1,6mm 100pc 010224 2,0mm 80pc 010225 2,0mm 400pc 010112 2,5mm 55pc 010125 2,5mm 275pc 010113 3,2mm 145pc 010114	Torcia TIG / TIG Torch TG17 140A - 4m Dx25/50mmq (1,6 WR2 acciaio-steel) 010068		Bacchette TIG / TIG rods L. 1000mm Kg 1,0 Inox 308L 1,6mm 011255 Inox 316L 1,6mm 011256 Inox 309L 1,6mm 011257	
Pinza di massa Earth clamp 200A + 2,7m 25mmq + DX25 010833		Basico / Basic E7018 2,5mm 230pc 011140 3,2mm 140pc 011041		Starter Kit per acciaio Starter Kit for Steel 2,4mm WR2 010072		
Attacchi / Welding plugs DX25mmq 010385		Inox / Stainless steel E308L 2,0mm 178pc 011039 2,5mm 102pc 010115 Ghisa /Cast iron E1071 2,5mm 16pc 010130		Regolatore di pressione + adattatore CO2 ⇔ Ar (IT / USA) Pressure regulator + adapter CO2 ⇔ Ar (IT / USA) 010835		
Posizionatore Position holder (1) MPH 92 010346 (2) MPH 62 010345			Martellina / Hammer 010341			
			Spazzola / Brush 010343			
				WM31 TC TRUE COLOUR GRINDING Filtro auto-oscurante 93x43mm Auto-darkening Filter 93x43mm DIN 9 - 13 010408		

MMA INVERTER



Manutenzione
Maintenance

Carpenteria leggera
Light carpentry

Cantiere edile
Construction site

Carpenteria pesante
Heavy carpentry

ELETTRODI CELLULOSICI
CELLULOSIC ELECTRODES

SPECIALE GENERATORE
GENERATOR USE



- Riduce la tensione di uscita per una migliore sicurezza nelle operazioni di saldatura
- It reduces the output voltage for better safety in welding operations

Saldatrice inverter MMA e TIG LIFT ideale per elettrodi cellulosici.

Maneggevole e robusta. Il design ergonomico la rende perfetta per il trasporto. i-ARC 319C è indicata sia per l'uso in officina che all'aperto: è la macchina ideale per le manutenzioni.

- Particolarmente adatta ad un uso con generatore
- Ideale per la saldatura con elettrodi a rivestimento cellulosico di tubi in tutte le posizioni e a basse correnti
- Offre eccellenti proprietà d'innesco ed un arco stabile.
- i-ARC 319C è indicata per le operazioni di saldatura di acciaio dolce, inox e alluminio.



I-ARC319C in versione completa di accessori
I-ARC319C in full version of accessories

Inverter MMA and TIG LIFT welding machine perfect choice for cellulosic electrodes.

Handy and sturdy welding machine. The lightweight ergonomic design makes it perfect to bring along. i-ARC 319C is suitable for both workshop and outdoor use: it is the ideal machine for maintenance.

- Specifically suitable for use with engine generator.
- Particularly appropriate for welding with cellulosic coated electrodes of pipes and plates in all positions at low welding currents.
- The machine has excellent ignition properties and a stable arc.
- i-ARC 319C is applicable for mild, stainless steel and aluminum welding operations.

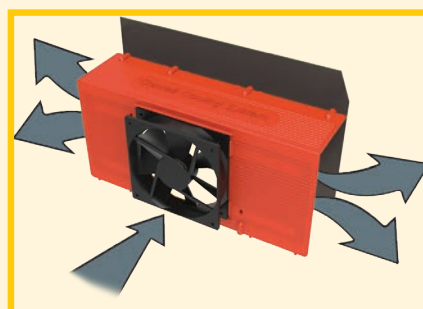

Ventilazione ad alte prestazioni
High performance air cooling



MADE IN SAN MARINO

**i-ARC 319C LAB**

Tensione di alimentazione - Input voltage	1 ph - 230V 50/60 Hz	
Potenza assorbita - Absorbed power: 60% / Max	3,3 / 5,6 kW	
Fusibile - Fuse	20A	
Generatore - Generator	+/- 30% (7 kW)	
Rendimento - Efficiency	> 80%	
	MMA DC	TIG DC
Campo di regolazione - Welding current range	10 - 180A	10 - 200A
Servizio DECA 20°C - DECA use 20°C	180A - 67%	-
	160A - 80%	-
Servizio 40°C - Duty cycle 40°C EN 60974-1	180A - 20%	200A - 20%
	130A - 60%	140A - 60%
Tensione a vuoto - Open circuit voltage	105V	
Elettrodi : Ø mm Electrodes: Ø mm	Rutile	1,6 - 4,0
	Basico - Basic	2,0 - 4,0
	Cellulosico Cellulosic	2,5 - 3,2
	Alluminio - Aluminum	2,5 - 3,2
	TIG	1,0 - 4,0
Connessioni in uscita - Output connection	DX 25 mmq	
Protezione termostatica - Thermostatic Protection	●	
Ventilata - Fan cooled	Convair Cooling System	
Peso - Weight ≈	5,6 kg	
Dimensioni - Dimensions	365 x 160 x 273 mm	

Versione - Version

Solo generatore - Power source only	286200
*Generatore + accessori *Power source + accessories	286280

*Accessori in dotazione - Supplied accessories:



+



+

+ 25 mm² 2,3 m +

+

+ 25 mm² - 1,7m**Caratteristiche**

- Alimentazione da rete o da generatore.
- Indicazione macchina alimentata.
- Indicazione protezione termostatica.
- Ventilazione ad alta efficienza.
- Due modalità di saldatura: **TIG DC LIFT** per tutti i materiali eccetto alluminio e sue leghe. **MMA** per la maggior parte degli elettrodi, compresi quelli a rivestimento **CELLULOSICO**.

Funzioni MMA

- **Hot Start**: eroga ampere aggiuntivi per i primi secondi quando si innesca l'arco. Aiuta ad ottenere la giusta temperatura del bagno di saldatura.
- **Arc Force regolabile**: permette di aggiustare il tempo di reazione della macchina ai corto circuiti. Riduce il rischio d'incollare l'elettrodo al pezzo da saldare.
- **Anti-sticking**: nel caso in cui l'elettrodo si incollò al pezzo da saldare, la corrente di saldatura è ridotta a pochi ampere per rendere più facile il distacco dell'elettrodo.

Funzioni TIG

- **TIG DC**: Torcia con rubinetto ed innesco LIFT.

Features

- Power supply from mains or generator.
- Power indicator light.
- Thermostatical protection indicator light.
- High efficiency air cooling.
- Two welding modes: **TIG DC LIFT** for welding all materials except aluminum and aluminum alloys. **MMA** for welding with most types of electrodes included **CELLULOSIC** ones.

MMA Features

- **Hot Start**: It provides extra amps for the first seconds when igniting the arc. It helps create the right temperature in the weld pool.
- **Adjustable Arc Force**: it makes possible to adjust the machine reaction time to short circuit. It reduces the risk of the electrode sticking to the weld pool.
- **Anti-sticking**: In case the electrode sticks to the weld pool, the welding current will decrease to few amps, making it easy to break off the electrode.

TIG Features

- **TIG DC**: TIG with LIFT arc striking (Torch with gas valve).

Accessori - Accessories MMA pag.99

Optional and Consumable

Pinza porta elettrodo Electrode holder 200A + 2,7m 25mmq + DX25 010834		Elettrodi / Electrodes Rutile E6013 1,6mm 100pc 010224 2,0mm 80pc 010225 2,0mm 400pc 010112 2,5mm 55pc 010125 2,5mm 275pc 010113 3,2mm 145pc 010114	Torcia TIG / TIG Torch TG17 140A - 4m Dx25/50mmq (1,6 WR2 acciaio-steel) 010068		Bacchette TIG / TIG rods L. 1000mm Kg 1,0 Inox 308L 1,6mm 011255 Inox 316L 1,6mm 011256 Inox 309L 1,6mm 011257	
Pinza di massa Earth clamp 200A + 2,7m 25mmq + DX25 010833		Basico / Basic E7018 2,5mm 230pc 011040 3,2mm 140pc 011041	Starter Kit per acciaio Starter Kit for Steel 2,4mm WR2 010072			
Attacchi / Welding plugs DX25mmq 010385		Inox / Stainless steel E308L 2,0mm 178pc 011039 2,5mm 102pc 010115 Ghisa /Cast iron E1071 2,5mm 16pc 010130	Regolatore di pressione + adattatore CO2 ⇔ Ar (IT / USA) Pressure regulator + adapter CO2 ⇔ Ar (IT / USA) 010835		WM31 TC TRUE COLOUR GRINDING Filtro auto-oscurante 93x43mm	
Posizionatore Position holder (1) MPH 92 010346 (2) MPH 62 010345			Martellina / Hammer 010341 Spazzola / Brush 010343		Auto-darkening Filter 93x43mm DIN 9 - 13 010408	

MMA INVERTER 3Ph

Manutenzione
Maintenance
Carpenteria leggera
Light carpentry
Cantiere edile
Construction site



ELETTRODI CELLULOSICI
CELLULOSIC ELECTRODES

SPECIALE GENERATORE
GENERATOR USE



- Riduce la tensione di uscita per una migliore sicurezza nelle operazioni di saldatura
- It reduces the output voltage for better safety in welding operations

Macchina trifase ad alte prestazioni per la saldatura professionale.

La i-ARC 525 è indicata sia per la saldatura in officina che per le riparazioni in esterno.



- Particolarmente adatta ad un uso con generatore.
- Offre eccellenti proprietà d'innesco ed un arco stabile. E' indicata per la saldatura di acciaio dolce ed inox.
- Consente la saldatura TIG con innesco LIFT.

Three-phase, high-performance MMA welding machine for advanced MMA welding jobs.

i-ARC 525 is appropriate for both workshop and outdoor use.

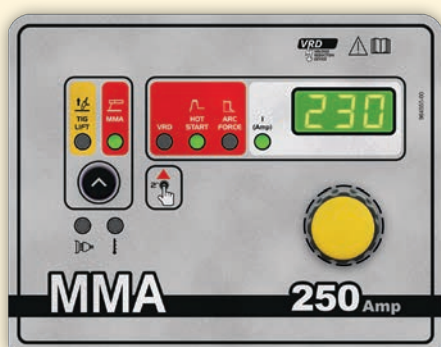
- Specifically suitable for use with engine generator.
- The machines have excellent ignition properties and a stable arc. i-ARC 525 is applicable for mild and stainless steel welding operations.
- TIG welding available with LIFT ARC ignition.



				i-ARC525 LAB	
Tensione di alimentazione - Input voltage 50/60 Hz		3 ph - 400V ± 30%			
Potenza assorbita - Absorbed power: 60% / Max		4 / 7,5 kW			
Fusibile - Fuse		10A			
Generatore - Generator		+/- 30% (12 kW)			
Rendimento - Efficiency		> 85%			
		MMA DC		TIG DC	
Campo di regolazione - Welding current		10 -250A		10 -250A	
Servizio 40°C - Duty cycle 40°C EN 60974-1		230A - 25%		230A - 25%	
		150A - 60%		160A - 60%	
Tensione a vuoto - Open circuit voltage		85V		85V	
Elettrodi Electrodes: ø mm	Rutile	1,6 - 5,0			
	Basico - Basic	1,6 - 5,0			
	Cellulosico Cellulosic	-			
	Alluminio - Aluminum	-			
	TIG	1,0 - 4,0			
Connessioni - Connection		DX 50 mmq			
Peso - Weight ≈		10,7 kg			
Dimensioni - Dimensions		450 x 210 x 365			
Versione - Version					
Solo generatore - Power source only		286600			

Caratteristiche

- Alimentazione da rete o da moto generatore.
- Indicazione macchina alimentata.
- Indicazione protezione termostatica.
- Ventilazione ad alta efficienza.
- Due modalità di saldatura: **TIG DC LIFT** per tutti i materiali eccetto alluminio e sue leghe. **MMA** per la maggior parte degli elettrodi.

Funzioni MMA

- **Hot Start regolabile:** eroga ampere aggiuntivi per i primi secondi quando si innesca l'arco. Aiuta ad ottenere la giusta temperatura del bagno di saldatura.
- **Arc Force regolabile:** permette di aggiustare il tempo di reazione della macchina ai corto circuiti. Riduce il rischio d'incollare l'elettrodo al pezzo da saldare.
- **Anti-sticking:** nel caso in cui l'elettrodo si incolla al pezzo da saldare, la corrente di saldatura è ridotta a pochi ampere per rendere più facile il distacco dell'elettrodo.

Funzioni TIG

- **TIG DC:** torcia con rubinetto ed innesco LIFT.

Features

- Power supply from the mains or from motor generator.
- Power indicator light.
- Thermostatical protection indicator light.
- High efficiency air cooling.
- Two welding modes: **TIG DC LIFT** for welding all materials except aluminum and aluminum alloys. **MMA** for welding with most types of electrodes.















MMA Features.

- **Adjustable Hot Start:** it provides extra amps for the first seconds when igniting the arc. It helps create the right temperature in the weld pool.
- **Adjustable Arc Force:** it makes possible to adjust the machine reaction time to short circuit. It reduces the risk of the electrode sticking to the weld pool.
- **Anti-sticking:** In case the electrode sticks to the weld pool, the welding current will decrease to few amps, making it easy to break off the electrode.

TIG Features

- **TIG DC:** TIG with LIFT arc striking (Torch with gas valve).

Accessori - Accessories MMA pag.99

Optional and Consumable						
Pinza porta elettrodo Electrode holder 300A + 3,0m 35mmq + DX50 010070		Elettrodi / Electrodes Rutile E6013 1,6mm 100pc 010224 2,0mm 80pc 010225 2,0mm 400pc 010112 2,5mm 55pc 010125 2,5mm 275pc 010113 3,2mm 145pc 010114	Torcia TIG / TIG Torch TG17 140A - 4m Dx 50mmq (1,6 WR2 acciaio-steel) 010825		Bacchette TIG / TIG rods L. 1000mm Kg 1,0 Inox 308L 1,6mm 011255 Inox 316L 1,6mm 011256 Inox 309L 1,6mm 011257	
Pinza di massa Earth clamp 350A + 3m 35mmq + DX50 010314		Basico / Basic E7018 2,5mm 230pc 011040 3,2mm 140pc 011041		Starter Kit per acciaio Starter Kit for Steel 2,4mm WR2 010072		
Attacchi Welding plugs DX50 010386		Inox / Stainless steel E308L 2,0mm 178pc 011039 2,5mm 102pc 010115 Ghisa / Cast iron E1071 2,5mm 16pc 010130		Regolatore di pressione + adattatore CO2 ⇔ Ar (IT / USA) Pressure regulator + adapter CO2 ⇔ Ar (IT / USA) 010835		WM31 TC TRUE COLOUR GRINDING Filtro auto-oscurante 93x43mm
Posizionatore Position holder (1) MPH 92 010346 (2) MPH 62 010345				Martellina / Hammer 010341		Auto-darkening Filter 93x43mm DIN 9 - 13 010408
				Spazzola / Brush 010343		

i-ARC 530C LAB Cellulosic

DC
-+

MMA PULSE INVERTER 3Ph

SOON 2023

MMA PULSE



Manutenzione
Maintenance

Carpenteria leggera
Light carpentry

Cantieri edile
Construction site

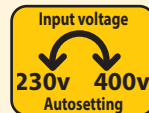

ELETTRODI CELLULOSICI
CELLULOSIC ELECTRODES



- Riduce la tensione di uscita per una migliore sicurezza nelle operazioni di saldatura
- It reduces the output voltage for better safety in welding operations

Macchina trifase ad alte prestazioni per la saldatura professionale.

i-ARC 530C è particolarmente adatta per la saldatura con elettrodi a rivestimento CELLULOSICO di tubi in tutte le posizioni e a basse correnti.

La i-ARC 530C è indicata sia per la saldatura in officina che per le riparazioni in esterno.

- Particolarmente adatta ad un uso con generatore.
- Offre eccellenti proprietà d'innescò ed un arco stabile. E' indicata per la saldatura di acciaio dolce ed inox.
- Consente la saldatura TIG con innescò LIFT.



Three-phase, high-performance MMA welding machine for advanced MMA welding jobs.

i-ARC 530C is particularly suitable for welding with CELLULOSIC coated electrodes of pipes and plates in all positions at low welding currents.

i-ARC 530C is appropriate for both workshop and outdoor use.

- Specifically suitable for use with engine generator.
- The machines has excellent ignition properties and a stable arc. i-ARC 530C is applicable for mild and stainless steel welding operations.
- TIG welding available with LIFT ARC ignition.



 MADE IN SAN MARINO				i-ARC 530C LAB	
Tensione di alimentazione Input voltage 50/60 Hz		3 ph - 400V ± 15% (autosetting)	3 ph - 230V ± 15% (autosetting)		
Potenza assorbita - Absorbed power: 60% / Max		5 / 8,5 kW	4 / 6 kW		
Fusibile - Fuse		16A	16A		
Generatore - Generator		+/- 15% (13 kW)	+/- 15% (10 kW)		
Rendimento - Efficiency		> 85%	> 85%		
Campo di regolazione - Welding current		10 - 270A	10 - 220A		
Servizio 40°C - Duty cycle 40°C EN 60974-1		270A - 35% (TIG 300A)	220A - 35% (TIG 280A)		
		220A - 60% (TIG 250A)	180A - 60% (TIG 240A)		
Tensione a vuoto - Open circuit voltage		61V	58V		
Elettrodi Electrodes: ø mm	Rutile	1,6 - 5,0			
	Basico - Basic	2,0 - 5,0			
	Cellulosico Cellulosic	2,5 - 3,2			
	Alluminio - Aluminum	2,5 - 3,2			
	TIG	1,0 - 4,0			
Connessioni - Connection		DX 50 mmq			
Peso - Weight ≈		19,0 kg			
Dimensioni - Dimensions		580 x 230 x 430			
Versione - Version					
Solo generatore - Power source only		286900			

Caratteristiche

- Alimentazione da rete o da moto generatore.
- Indicazione macchina alimentata.
- Indicazione protezione termostatica.
- Ventilazione ad alta efficienza.
- Due modalità di saldatura: **TIG DC LIFT** per tutti i materiali eccetto alluminio e sue leghe. **MMA** per la maggior parte degli elettrodi, compresi quelli a rivestimento **CELLULOSICO**.

Funzioni MMA

- **Hot Start regolabile:** eroga ampere aggiuntivi per i primi secondi quando si innesca l'arco. Aiuta ad ottenere la giusta temperatura del bagno di saldatura.
- **Arc Force regolabile:** permette di aggiustare il tempo di reazione della macchina ai corto circuiti. Riduce il rischio d'incollare l'elettrodo al pezzo da saldare.
- **Anti-sticking**
- **Saldatura sinergica:** pe ottenere le prestazioni ottimali con i vari elettrodi basici, rutili ed inox.
- **Saldatura pulsata** con la regolazione della frequenza per ridurre l'apporto termico.

Funzioni TIG

- **TIG DC:** torcia con rubinetto ed innesco LIFT.

Features

- Power supply from the mains or from motor generator.
- Power indicator light.
- Thermostatical protection indicator light.
- High efficiency air cooling.
- Two welding modes: **TG DC LIFT** for welding all materials except aluminum and aluminum alloys. **MMA** for welding with most types of electrodes included **CELLULOSIC** ones.















MMA Features.

- **Adjustable Hot Start:** it provides extra amps for the first seconds when igniting the arc. It helps create the right temperature in the weld pool.
- **Adjustable Arc Forc:** it makes possible to adjust the machine reaction time to short circuit . It reduces the risk of the electrode sticking to the weld pool.
- **Anti-sticking**
- **Sinergic welding:** to ensure optimal welding performance with Basic, Rutile and stainless steel electrodes.
- **Pulse welding:** with adjustable frequency, to reduce heat input.

TIG Features

- **TIG DC:** TIG with LIFT arc striking (Torch with gas valve).

Accessori - Accessories MMA pag.99

Optional and Consumable							
Pinza porta elettrodo Electrode holder 300A + 3,0m 35mmq + DX50 010070		Elettrodi / Electrodes Rutile E6013 1,6mm 100pc 010224 2,0mm 80pc 010225 2,0mm 400pc 010112 2,5mm 55pc 010125 2,5mm 275pc 010113 3,2mm 145pc 010114		Torcia TIG / TIG Torch TG17 140A - 4m Dx 50mmq (1,6 WR2 acciaio-steel) 010825		Bacchette TIG / TIG rods L. 1000mm Kg 1,0 Inox 308L 1,6mm 011255 Inox 316L 1,6mm 011256 Inox 309L 1,6mm 011257	
Pinza di massa Earth clamp 350A + 3m 35mmq + DX50 010314		Basico / Basic E7018 2,5mm 230pc 011040 3,2mm 140pc 011041		Starter Kit per acciaio Starter Kit for Steel 2,4mm WR2 010072			
Attacchi Welding plugs DX50 010386		Inox / Stainless steel E308L 2,0mm 178pc 011039 2,5mm 102pc 010115 Ghisa / Cast iron E1071 2,5mm 16pc 010130		Regolatore di pressione + adattatore CO2 ⇔ Ar (IT / USA) Pressure regulator + adapter CO2 ⇔ Ar (IT / USA) 010835		WM31 TC TRUE COLOUR GRINDING Filtro auto-oscurante 93x43mm	
Comando remoto 9m Remote control 9m 010840		Posizionatore Position holder (1) MPH 92 010346 (2) MPH 62 010345		Martellina / Hammer 010341 Spazzola / Brush 010343		Auto-darkening Filter 93x43mm DIN 9 - 13 010408	

TIG PULSE - MMA INVERTER



Manutenzione
Maintenance
Carpenteria leggera
Light carpentry
Autoriparazioni
Automotive
Saldatura di precisione
Precision welding

Macchine monofase inverter MMA e TIG in versione DC o AC/DC.

Le Mastrotig serie 2 sono saldatrici affidabili progettate per le operazioni di saldatura più complesse. Possono essere utilizzate per materiali quali l'acciaio dolce, l'acciaio inox e l'alluminio (Mastrotig 216). Eccellenti per l'installatore e per l'uso in officina.

- Il pannello di controllo presenta tasti con icone e un display digitale che mostra l'ampereaggio o i parametri secondari. Consente di selezionare e regolare con facilità i parametri desiderati.
- L'accensione è ad alta frequenza o LIFT che permette di saldare nei pressi di dispositivi elettronici sensibili.
- La funzione di saldatura pulsata offre un controllo migliore del bagno di saldatura. Ciò vale soprattutto per la saldatura di posizione o di laminati metallici.
- Il pannello di controllo AC/DC del modello Mastrotig 216 permette di saldare l'alluminio e le sue leghe.
- La funzione EASY PULSE regola automaticamente la corrente base e la frequenza di pulsazione in funzione della corrente di picco impostata, semplificando la saldatura TIG sia DC che AC.
- La funzione AC EASY regola la frequenza ed il bilanciamento dell'onda alternata in funzione della corrente impostata semplificando la saldatura TIG con corrente alternata.

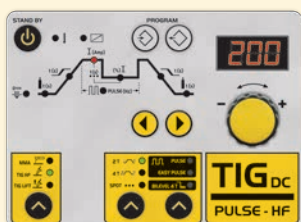

MASTROTIG 218 DC

MMA and TIG single-phase inverter welding machines in DC or AC/DC version

Mastrotig 2 Series range are reliable welding machines designed for the most complex welding operations. They can be used for materials such as mild steel, stainless steel and aluminium (Mastrotig 216). They are excellent for on-site installers and for workshop use.

- The intuitive control panel consists of icon-based buttons and a digital display showing amperage or secondary parameters. It allows to easily select and adjust the desired parameters.
- High-frequency or LIFT ignition, which allows to weld near sensitive electronic devices.
- The pulse function provides better control of the weld pool. This applies in particular when used for position welding or sheet metal welding.
- Mastrotig 216 AC/DC control panel allows to weld aluminum and aluminum alloys.
- EASY PULSE feature adjusts base current and pulsation frequency according to the set peak current. It considerably simplifies the TIG welding process, both in DC and AC.
- AC EASY feature adjusts automatically frequency and balance of the alternating wave according to the current set. It considerably simplifies the TIG welding process with alternating current.



MASTROTIG 216 AC/DC

MADE IN SAN MARINO		CE		MASTROTIG 218 DC LAB	MASTROTIG 216 AC/DC LAB
Tensione di alimentazione - Input voltage		1 ph - 230V 50/60 Hz		1 ph - 230V 50/60 Hz	
Potenza assorbita- Absorbed power: 60% / Max		3,3 / 5,7 kW		2 / 4 kW	
Fusibile - Fuse		25A		16A	
Generatore - Generator		+/- 15% (9 kW)		+/- 15% (6 kW)	
Rendimento - Efficiency		> 80%		> 80%	
Campo di regolazione - Welding current		TIG DC	MMA	TIG AC / DC	MMA
5 - 200A		20 - 180A	5 - 160A	20 - 130A	
Servizio 40°C - Duty cycle 40°C EN 60974-1		200A - 30% 140A - 60%	180A - 30% 130A - 60%	160A - 20% 85A - 60%	130A - 25% 80A - 60%
Tensione a vuoto - Open circuit voltage		90V		105V	
Elettrodi : ø mm Electrodes: ø mm	Rutile / Basico - Basic	1,6 - 5,0		1,6 - 3,2	
	TIG	1,0 - 4,0		1,0 - 3,2	
Connessioni in uscita - Output connection		DX 25 mmq		DX 25 mmq	
Protezione termostatica - Thermostatic Protection		●		●	
Peso - Weight ≈		9 kg		12 kg	
Dimensioni - Dimensions		430 x 200 x 344 mm		418 x 200 x 415 mm	
Codice - Code		284100		284200	

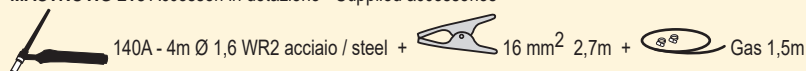
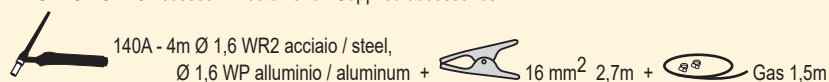
MASTROTIG 218 Accessori in dotazione - Supplied accessories**MASTROTIG 216** Accessori in dotazione - Supplied accessories

Accessori - Accessories TIG pag.102

Optional and Consumable					
Elettrodi / Electrodes WC20 (acciaio/steel) Tungsteno/Cerio 2% Tungsten/Cerium 2% 1,6mm 10pc 010694 2,4mm 10pc 010696 3,2mm 10pc 010668 4,0mm 10pc 010663 WP (alluminio/aluminum) Tungsteno puro Tungsten 1,6mm 10pc 010697 2,4mm 10pc 010699 3,2mm 10pc 010700		Starter Kit per acciaio Starter Kit for Steel 2,4mm WR2 010072	 Pinza porta elettrodo Electrode holder 200A + 2,7m 16mmq + DX25 010069	 WM40 TC True Colour / Grinding DIN 5-9 / 9-13 Filtro auto-oscurante a colori reali 100x60mm True colour auto-darkening filter 100x60mm 010414	
		Starter Kit Fe + Al 2,4 / 3,2mm WR2 Acciaio / Steel 1,6 / 2,,4 / 3,2mm WP Alluminio / Aluminum 010083	Comando a pedale 9m Foot remote control 9m 010395	CR26 Carrello / Trolley 010890	
Bacchette TIG / TIG rods L. 1000mm Kg 1,0 Inox 308L 1,6mm 011255 Inox 316L 1,6mm 011256 Inox 309L 1,6mm 011257 AlMg5 1,6mm 011258 AISi5 1,6mm 011259		Regolatore di pressione + adattatore CO2 ↔ Ar (IT / USA) Pressure regulator + adapter CO2 ↔ Ar (IT / USA) 010836	Comando remoto 9m Remote control 9m 010390		
		Regolatore di pressione + adattatore CO2 ↔ Ar (IT / USA) Pressure regulator + adapter CO2 ↔ Ar (IT / USA) 010837	Posizionatore Position holder (1) MPH 92 010346 (2) MPH 62 010345 		

Funzioni TIG

- Innesco dell'arco con LIFT o HF.
- **Corrente DC pulsata** con funzione **EasyPulse**.
- Corrente AC pulsata con funzione **AC-Easy** (Mastrotig 216).
- Corrente AC con funzione balance: rapporto fra la durata della semionda positiva e della semionda negativa.
- Bilevel (Mastrotig 216).
- Pre-gas, Post-gas regolabili.
- Slope up, Slope down regolabili.
- Funzioni pulsante torcia: 2/4T / Spot.
- Memorizzazione 9 programmi.

Funzioni MMA

- Hot Start regolabile.
- Arc Force regolabile.
- Anti-sticking.

TIG Features

- LIFT or HF arc striking.
- **Pulse DC current** with **EasyPulse** function.
- Pulse AC current with **AC-Easy** function (Mastrotig 216).
- AC current with balance function: ratio between the duration of the positive and the negative half waves.
- Bilevel (Mastrotig 216).
- Adjustable Pre-gas, Post-gas.
- Adjustable Slope up, Slope down.
- Torch trigger mode: 2/4T / Spot.
- 9 programs saving.

MMA Features

- Adjustable Hot Start.
- Adjustable Arc Force.
- Anti-sticking.

MASTROTIG 330

LAB

DC
-+

TIG PULSE - MMA PULSE INVERTER 3Ph

SOON 2023



Manutenzione
Maintenance
Carpenteria leggera
Light carpentry
Autoriparazioni
Automotive
Saldatura di precisione
Precision welding

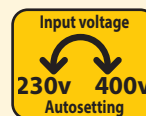

Saldatrice trifase inverter TIG DC, TIG PULSE ed MMA PULSE. Moderno generatore per saldatura, totalmente controllato da microprocessore. Progettato per le operazioni di saldatura più complesse, può essere utilizzato per saldare con processo TIG DC l'acciaio dolce e l'acciaio inox.

- Il pannello di controllo presenta un display grafico ad icone che visualizza i principali parametri e permette in modo facile ed intuitivo di selezionare e regolare tutte le funzioni utili al processo di saldatura.
- L'accensione TIG può essere ad alta frequenza o LIFT nel caso di vicinanza con dispositivi elettronici sensibili.
- La funzione TIG pulsata offre un migliore controllo del bagno di saldatura, particolarmente utile nell'unione di laminati sottili o parti in acciaio inox.
- La funzione EASY PULSE agevola anche gli utenti meno esperti. Molti dei parametri vengono gestiti automaticamente in funzione della corrente di saldatura e del diametro dell'elettrodo di tungsteno.
- Saldatura MMA in modalità sinergica. La qualità e la dinamica dell'arco cambia in funzione del rivestimento dell'elettrodo: rutile, basico, acido, ecc.
- Connettore multipolare utilizzare un'ampia varietà di comandi a distanza.

TIG DC, PULSE TIG and PULSE MMA three-phase inverter welding machine.

Modern generator for welding, with total microprocessor control. Designed for the most complex welding operations. It can be used to weld mild steel and stainless steel with TIG DC process.

- The intuitive control panel consists of icon-based buttons and a digital display showing the main parameters and it allows to easily select and adjust the desired parameters.
- High-frequency or LIFT ignition, which allows to weld near sensitive electronic devices.
- The pulse TIG function provides better control of the weld pool. Particularly useful for the union of thin laminates or stainless steel parts.
- The EASY PULSE function supports also the less experted operators. Most parameters are automatically managed according to the welding current and to the diameter of the tungsten electrode.
- MMA welding in synergic mode. The quality and the dynamic of the arc changes according to the electrode coating: rutile, basic, acid, etc.
- Multipolar connector for a wide range of remote control.



Memorizzazione jobs utente
User jobs Saving

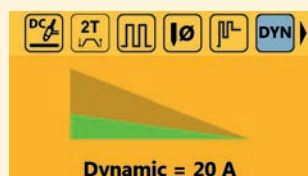

Impostazione TIG Dynamic
TIG Dynamic setting

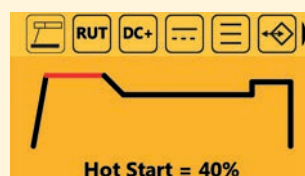

Regolazione parametri di saldatura
Welding parameters adjusting



Impostazione Rapid Start
Rapid Start setting

MADE IN SAN MARINO		MASTROTIG 330 LAB			
Tensione di alimentazione Input voltage 50/60 Hz		3 ph - 400V ± 15% (autosetting)		3 ph - 230V ± 15% (autosetting)	
Potenza assorbita - Absorbed power: 60% / Max		5 / 8,5 kW		4 / 6 kW	
Fusibile - Fuse		16A		16A	
Generatore - Generator		+/- 15% 13 kW		+/- 15% 10 kW	
Rendimento - Efficiency		> 85%		> 85%	
Campo di regolazione - Welding current		TIG DC	MMA	TIG DC	MMA
		10 - 300A	10 - 270A	10 - 280A	10 - 220A
Servizio 40°C - Duty cycle 40°C EN 60974-1		300A - 35%	270A - 35%	280A - 35%	220A - 35%
		250A - 60%	220A - 60%	240A - 60%	180A - 60%
Tensione a vuoto - Open circuit voltage		61V		58V	
Elettrodi Electrodes: ø mm	Rutile	1,6 - 5,0			
	Basico - Basic	2,0 - 5,0			
	TIG	1,0 - 4,0			
Conessioni - Connection		DX 50 mmq			
Protezione termostatica Thermostatic Protection		•			
Peso - Weight ≈		19,0 kg			
Dimensioni - Dimensions		580 x 230 x 430			
Versione - Version					
Solo generatore - Power source only		286800			

Accessori in dotazione - Supplied accessories

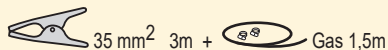

Accessori - Accessories TIG pag.102

Funzioni TIG

- Innesco dell'arco con LIFT o HF.
- Corrente **DC pulsata** con funzione **EasyPulse**.
- Corrente DC con funzione balance.
- Bilevel.
- Pre-gas, Post-gas regolabili.
- Slope up, Slope down regolabili.
- Funzioni pulsante torcia: 2/4T / Spot
- Memorizzazione jobs utente.
- **Rapid start**: per riscaldare il bagno di fusione più rapidamente al momento della partenza.
- **TIG Dynamic**: aumenta o diminuisce la corrente di saldatura al variare della lunghezza d'arco.
- **SPOT mirato**: per centrare con l'elettrodo il punto esatto di saldatura prima di azionare l'innescio HF.

Funzioni MMA

- Hot Start ed Arc Force regolabili. Anti-sticking.
- **Saldatura sinergica**: per ottenere le prestazioni ottimali con i vari elettrodi basici, rutili ed inox.
- **Saldatura pulsata**: con la regolazione della frequenza per ridurre l'apporto termico.

TIG Features

- LIFT or HF arc striking.
- **Pulse DC** current with **EasyPulse** function.
- DC current with balance function.
- Bilevel.
- Adjustable Pre-gas, Post-gas.
- Adjustable Slope up, Slope down.
- Torch trigger mode: 2/4T / Spot
- User jobs saving.
- **Rapid start**: it heats up the weld pool more quickly upon start-up.
- **Dynamic TIG**: it increases or decreases the welding current as the arc length varies.
- **Targeted SPOT**: it allows to center with the electrode the exact welding point before HF ignition

MMA Features

- Adjustable Hot Start and Arc Force. Anti-sticking.
- **Synergic welding**: to obtain optimal performance with the various basic, rutile and stainless steel electrodes.
- **Pulse welding** with frequency regulation to reduce heat input.

Optional and Consumable

Torcia TIG / TIG Torch Expertig 18 H2O 320A DC "Tyco" (1,6mm WR2) 4mt 010514 8mt 010519		Starter Kit per acciaio Starter Kit for Steel 2,4mm WR2 010072		Pinza porta elettrodo Electrode holder 300A + 3,0m 35mmq + + DX50 010070		Elettrodi / Electrodes WC20 (acciaio/steel) Tungsteno/Cerio 2% Tungsten/Cerium 2% 1,6mm 10pc 010694 2,4mm 10pc 010696 3,2mm 10pc 010668 4,0mm 10pc 010663	
WUT33 Unità di raffreddamento Cooling unit 010838		Comando a pedale 9m Foot control 9m 010839		Regolatore di pressione + adattatore CO2 ↔ Ar (IT / USA) Pressure regulator + adapter CO2 ↔ Ar (IT / USA) 010837			
Torcia TIG / TIG Torch Expertig 26 180A DC "Tyco" (1,6mm WR2) 4m 010789 8m 010804		Comando remoto 9m Remote control 9m 010840		Bacchette TIG / TIG rods L. 1000mm Kg 1,0 Inox 308L 1,6mm 011255 Inox 316L 1,6mm 011256 Inox 309L 1,6mm 011257		WM40 TC True Colour / Grinding DIN 5-9 /9-13 Filtro auto-oscurante a colori reali 100x83mm True colour auto- darkening filter 100x83mm 010414	
CRG160 Carrello / Trolley 010849							

TIG PULSE - MMA INVERTER 3Ph



Manutenzione
Maintenance
Carpenteria leggera
Light carpentry
Saldatura di precisione
Precision welding

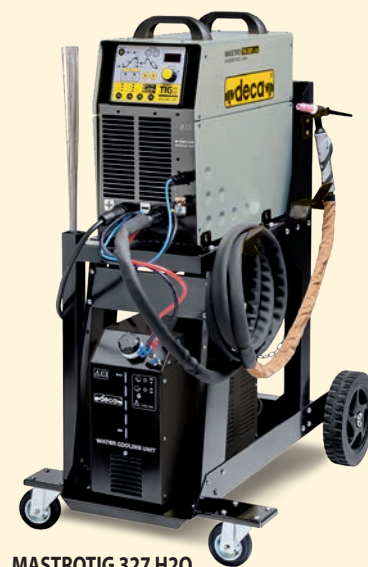

MASTROTIG 327 H20

Macchina trifase inverter TIG AC/DC e MMA.

La Mastrotig 327 è una saldatrice progettata per le operazioni di saldatura complesse. Può essere utilizzata per saldare l'acciaio dolce, l'acciaio inox e l'alluminio.

- Il pannello di controllo presenta tasti con icone e un display digitale che mostra l'ampereaggio, il voltaggio o i parametri secondari. Consente di selezionare e regolare con facilità i parametri desiderati.
- L'accensione dell'arco è ad alta frequenza o LIFT nel caso di vicinanza con dispositivi elettronici sensibili.
- La funzione di saldatura pulsata offre un controllo migliore del bagno di saldatura. Ciò vale soprattutto per la saldatura di posizione o di laminati metallici.
- Il pannello di controllo AC/DC permette di saldare l'alluminio
- La funzione EASY PULSE regola automaticamente la corrente base e la frequenza di pulsazione in funzione della corrente di picco impostata, semplificando la saldatura TIG
- La funzione AC EASY regola la frequenza ed il bilanciamento dell'onda alternata in funzione della corrente impostata semplificando la saldatura TIG con corrente alternata.

TIG AC/DC and MMA three-phase inverter machine.

Mastrotig 327 is a welding machines designed for complex welding operations. It can be used for welding in mild steel, stainless steel and aluminum.

- The intuitive control panel consists of icon-based buttons and a digital display showing amperage, voltage or secondary parameters. It allows to easily select and adjust the desired parameters.
- High-frequency or LIFT ignition, which allows to weld near sensitive electronic devices.
- The pulse function provides better control of the weld pool. This applies in particular when used for position welding or sheet metal welding.
- AC/DC control panel allows to weld aluminum
- EASY PULSE feature adjusts base current and pulsation frequency according to the set peak current. It considerably simplifies the TIG welding process.
- AC EASY feature adjusts frequency and balance of the alternating wave according to the current set. It considerably simplifies the TIG welding process with alternating current.



MADE IN SAN MARINO		CE	MASTROTIG 327 AC/DC LAB
Tensione di alimentazione - Input voltage		3 ph - 400V 50/60 Hz	
Potenza assorbita- Absorbed power: 60% / Max		7 / 10 kW	
Fusibile - Fuse		16A	
Generatore - Generator		+/- 15% (15 kW)	
Rendimento - Efficiency		> 85%	
		TIG AC / DC	MMA
Campo di regolazione - Welding current		5 - 270	20 - 270A
Servizio 40°C - Duty cycle 40°C EN 60974-1		270A - 40%	270A - 40%
		215A - 60%	215A - 60%
Tensione a vuoto - Open circuit voltage		55V	
Elettrodi : ø mm Electrodes: ø mm	Rutile / Basico - Basic	1,5 - 6	
	TIG	1 - 4	
Conessioni in uscita - Output connection		DX 50 mmq	
Protezione termostatica - Thermostatic Protection		•	
Peso - Weight ≈		33 kg	
Dimensioni - Dimensions		550 x 250 x 500 mm	
Codice - Code		285000	

Accessori in dotazione - Supplied accessories

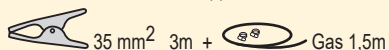

Funzioni TIG

- Innesco dell'arco con LIFT o HF.
- Corrente DC pulsata con funzione EasyPulse.
- Corrente DC con funzione balance.
- Bilevel.
- Pre-gas, Post-gas regolabili.
- Slope up, Slope down regolabili.
- Funzioni pulsante torcia: 2/4T / Spot
- Memorizzazione 9 programmi.

Funzioni MMA

- Hot Start regolabile.
- Arc Force regolabile.
- Anti-sticking.

TIG Features

- LIFT or HF arc striking.
- Pulse DC current with EasyPulse function.
- DC current with balance function.
- Bilevel.
- Adjustable Pre-gas, Post-gas.
- Adjustable Slope up, Slope down.
- Torch trigger mode: 2/4T / Spot
- 9 programs saving.

MMA Features

- Adjustable Hot Start.
- Adjustable Arc Force.
- Anti-sticking.

Accessori - Accessories TIG pag.102

Optional and Consumable					
Torcia TIG / TIG Torch Expertig 18 H2O 320A DC "Tyco" (1,6mm WR2) 4mt 010514 8mt 010519		Starter Kit per acciaio Starter Kit for Steel 2,4mm WR2 010072		Pinza porta elettrodo Electrode holder 300A + 3,0m 35mmq + + DX50 010070	WC20 (acciaio/steel) Tungsteno / Cerio 2% Tungsten / Cerium 2% 1,6mm 10pc 010694 2,4mm 10pc 010696 3,2mm 10pc 010668 4,0mm 10pc 010663
WU20 Unità di raffreddamento Cooling unit 010624		Starter Kit Fe + Al 2,4 / 3,2mm WR2 Acciaio / Steel 1,6 / 2,4 / 3,2mm WP Alluminio / Aluminum 010083		Regolatore di pressione + adattatore CO2 ⇔ Ar (IT / USA) Pressure regulator + adapter CO2 ⇔ Ar (IT / USA) 010837	WP (alluminio/aluminum) Tungsteno puro Tungsten 1,6mm 10pc 010697 2,4mm 10pc 010699 3,2mm 10pc 010700 4,0mm 10pc 010662
Torcia TIG / TIG Torch Expertig 26 180A DC "Tyco" (1,6mm WR2) 4m 010789 8m 010804		Comando a pedale 9m Foot control 9m 010395		Bacchette TIG / TIG rods L. 1000mm Kg 1,0 Inox 308L 1,6mm 011255 Inox 316L 1,6mm 011256 Inox 309L 1,6mm 011257	WM40 TC True Colour / Grinding DIN 5-9 /9-13 Filtro auto-oscurante a colori reali 100x60mm True colour auto- darkening filter 100x60mm 010414
CR27 Carrello / Trolley 010877		Comando remoto 9m Remote control 9m 010390		AIMg5 1,6mm 011258 AISi5 1,6mm 011259	

EasyJob 220 - 221XL

LAB

MULTIPROCESS MIG / MAG - NO GAS - MMA - TIG INVERTER

Manutenzione
Maintenance
Carpenteria leggera
Light carpentry

NEW!

NEW!



EasyJob
SPECIALE GENERATORE
GENERATOR USE

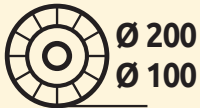

5 kg MAX

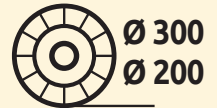

15 kg MAX

Queste saldatrici monofase inverter sono perfette per qualsiasi garage e officina ben attrezzata grazie alle loro proprietà di saldatura multiprocesso. Sono le saldatrici ideali per l'artigiano professionista che ha bisogno di vari processi di saldatura per le piccole riparazioni all'aperto e al chiuso. Estremamente compatte, sono disponibili in versione per alloggiare bobine di filo da 200mm oppure 300mm.

- Saldatura: MIG/MAG, FLUX, MMA e TIG Lift
- DC Sinergica. Tutti i parametri principali di saldatura sono collegati e agiscono in maniera combinata.
- Saldobrasatura MIG per acciaio galvanizzato.
- Inversione della polarità: da positiva a negativa e viceversa per saldare con fili animati.
- Pannello di controllo estremamente semplice per un utilizzo in modalità sinergica o manuale.
- Aggiornamento software tramite SD-Card.
- Pacchetto programmi standard di oltre 20 programmi per acciaio dolce, inox, alluminio.

These single-phase inverter welding machines are excellent for any garage and well-equipped workshop given their multi-process welding properties. They are the ideal welding machines for the professional craftsman, who needs different welding processes for minor repairs indoors as well as outdoors.

Extremely compact, they are available in 2 versions accommodating for 200mm or 300mm wire spools.

- Welding processes: MIG/MAG, FLUX, MMA, TIG Lift
- Synergic DC. All the primary welding parameters are linked and work together.
- MIG brazing process for galvanised steel.
- Polarity reversal: from positive to negative and viceversa for welding with flux cored wires.
- Extremely simple panel control for synergic or manual welding.
- Software update via SD-Card.
- Standard package of 20 welding programs for mild steel, stainless steel and aluminum.

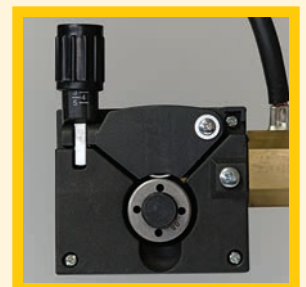

Trainafilo 2 rulli D.30mm
2 rolls wire feeder D.30mm

MADE IN SAN MARINO		EASYJOB 220 LAB		EASYJOB 221XL LAB	
Tensione di alimentazione - Input voltage		1 ph - 230V - 50/60 Hz		1 ph - 230V - 50/60 Hz	
Potenza assorbita - Absorbed power: 60% / Max		2,8 / 4,5 kW		2,8 / 4,5 kW	
Fusibile - Fuse		16A		16A	
Generatore - Generator		+/- 30% (7 kW)		+/- 30% (7 kW)	
Rendimento - Efficiency		> 80%		> 80%	
		MIG / TIG	MMA	MIG / TIG	MMA
Campi di regolazione - Welding current range		10 - 200A	10 - 160A	10 - 200A	10 - 160A
Corrente DC - Current DC (40°C EN 60974-1)		180A - 25% 100A - 60%	150A - 25% 100A - 60%	180A - 25% 100A - 60%	150A - 25% 100A - 60%
Tensione a vuoto - Open circuit voltage		86V		86V	
Filo ø mm Wires ø mm	Acciaio - Steel Sg2 Sg3	0,6 - 0,8 - 1,0		0,6 - 0,8 - 1,0	
	Inox AISI ER308 / ER316 / ER309	0,8 - 1,0		0,8 - 1,0	
	Al.Mg 5	0,8 - 1,0 - 1,2		0,8 - 1,0 - 1,2	
	Al.Si 5	1,0 - 1,2		1,0 - 1,2	
	Cu.Si 3 / Cu.Al 8	0,8 - 1,0 - 1,2		0,8 - 1,0 - 1,2	
	Filo animato - Flux cored	0,6 - 0,9 - 1,2		0,6 - 0,9 - 1,2	
Bobina ø mm- Wire spool ø mm		100 - 200		200 - 300	
MMA Elettrodi - Electrodes: ø mm		1,6 - 4,0		1,6 - 4,0	
Peso - Weight ≈		12 kg		13,7 kg	
Dimensioni - Dimensions		500 x 228 x 415 mm		556 x 268 x 438 mm	
Codice - Code		246000		246100	

Accessori in dotazione - Supplied accessories:

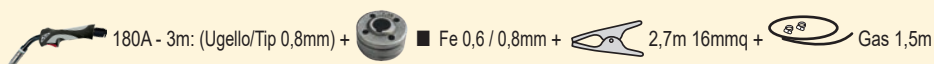

Caratteristiche

- Amperometro, Voltmetro.
- Cambio polarità per fili aminated.
- Trainafilo 2 rulli.

Funzioni MIG

- Saldatura sinergica.
- Induttanza elettronica.
- Hot Start regolabile.
- Burn back.

Funzioni MMA

- Hot Start.
- Arc Force regolabile.
- Anti-sticking.

Funzioni TIG

- **TIG DC:** Torcia con rubinetto ed innesco LIFT.
- Anti-sticking.
- Slope down regolabile.

Features

- Ammeter, Voltmeter.
- Reversed polarity for flux cored wires.
- 2 rolls wire feeder.

MIG Features

- Synergic welding.
- Electronic inductance.
- Adjustable Hot Start.
- Burn back.

MMA Features

- Hot Start.
- Adjustable Arc Force
- Anti-sticking.

TIG Features

- **Tig DC:** Torch with gas valve and lift ignition.
- Anti-sticking.
- Adjustable Slope down.

Accessori - Accessories MIG / MAG pag.104

Optional and Consumable							
Animato / Flux 0,9 2,0kg 010816 (Fe) Acciaio / Steel 0,6 5,0kg 010801 0,8 5,0kg 010805 1,0 5,0kg 010846 (AlMg5) Alluminio 1,0 2,0kg 010876 (AlSi) Alluminio 1,0 2,0kg 010860 (CuSi3) Brazing 0,8 2,0kg 010845		EP15 Pistol Grip 180 @ 60% 3 m 010507 4 m 010508		Torcia TIG / TIG Torch TG17 140A - 4m Dx25/50mmq (1,6 WR2 acciaio-steel) 010068		Pinza porta elettrodo Electrode holder 200A + 2,7m 16mmq + DX25 010069	
		DE 230A 230 @ 60% 3m 010584		Starter Kit per acciaio Starter Kit for Steel 2,4mm WR2 010072		CRMI Carrello / Trolley 010823	
Rullino trainafilo Wire roller Flux 0,9/1,0 011218 Flux 1,0/1,2 011219 Fe 1,0/1,2 011215 Al 0,8/1,0 011216 Al 1,0/1,2 011217		Starter kit Alu 1,0mm Guaina / Torch liner Al 1,0/1,2 (010856) + Ugello / Contact tip Al 1,0 3pc (010257) + Rullino / Wire roller Al 1,0/1,2 (011217)		Bacchette TIG / TIG rods L. 1000mm Kg 1,0 Inox 308L 011255 Inox 316L 011256 Inox 309L 011257		WM35 TC True Colour / Grinding DIN 5-9 / 9-13 Filtro auto-oscurante a colori reali 100x60mm True colour auto- darkening filter 100x60mm	
Regolatore di pressione + adattatore CO2 <-> Ar (IT / USA) Pressure regulator + adapter CO2 <-> Ar (IT / USA) 010836		010850					

EasyJob 520 - 525E

LAB

MULTIPROCESS MIG / MAG - NO GAS - MMA - TIG INVERTER

Manutenzione
Maintenance
Carpenteria leggera
Light carpentry
Autoriparazioni
Automotive



RUOTE INDUSTRIALI
HEAVY DUTY WHEELS

VANO PORTA ATTREZZI
TOOLS COMPARTMENT

Ø 300
Ø 200
15 kg MAX

Queste saldatrici monofase inverter sono perfette per qualsiasi garage e officina ben attrezzata grazie alle loro proprietà di saldatura multiprocesso. Sono l'ideale per l'artigiano professionista che ha bisogno di vari processi di saldatura per le piccole riparazioni e carpenteria leggera.

- Saldatura: MIG/MAG, FLUX, MMA e TIG Lift
- DC Sinergica. Tutti i parametri principali di saldatura sono collegati e agiscono in maniera combinata.
- Saldobrasatura MIG per acciaio galvanizzato.
- Inversione della polarità: da positiva a negativa e viceversa per saldare con fili animati.
- Pannello di controllo estremamente semplice per un utilizzo in modalità sinergica o manuale.
- Pacchetto programmi standard di oltre 20 programmi per acciaio dolce, inox, alluminio.
- Aggiornamento software tramite SD-Card.

These single-phase inverter welding machines are excellent for any garage and well-equipped workshop given they multi-process welding property. They are the ideal welding machines for the professional craftsman, who needs different welding processes for minor repairs indoors as well as outdoors.

- Welding processes: MIG/MAG, FLUX, MMA, TIG Lift
- Synergic DC. All the primary welding parameters are linked and work together.
- MIG brazing process for galvanised steel.
- Polarity reversal: from positive to negative and viceversa for welding with flux cored wires.
- Extremely simple control panel for synergic or manual welding.
- Standard package of 20 welding programs for mild steel, stainless steel and aluminum.
- Software update via SD-Card.



Supporto torcia
Torch holder

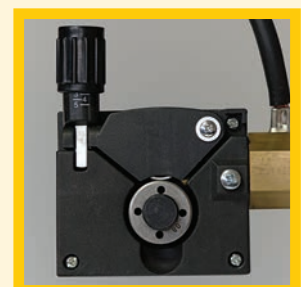

Trainafilo 2 rulli D.30mm
2 rolls wire feeder D.30mm

MADE IN SAN MARINO		EASYJOB 520		EASYJOB 525 E	
Tensione di alimentazione - Input voltage		1 ph - 230V - 50/60 Hz		1 ph - 230V - 50/60 Hz	
Potenza assorbita - Absorbed power: 60% / Max		2,8 / 4,5 kW		3,3 / 6,3 kW	
Fusibile - Fuse		16A		25A	
Generatore - Generator		+/- 30% (7 kW)		+/- 30% (9 kW)	
Rendimento - Efficiency		> 80%		> 80%	
Campo di regolazione - Welding current range		MIG / TIG	MMA	MIG / TIG	MMA
Corrente DC - Current DC (40°C EN 60974-1)		180A - 25%	150A - 25%	220 - 20%	180A - 25%
Tensione a vuoto - Open circuit voltage		86V		96V	
Filo ø mm Wires ø mm	Acciaio - Steel	0,6 - 0,8 - 0,9 - 1,0		0,6 - 0,8 - 0,9 - 1,0 - 1,2	
	Inox	0,8 - 1,0		0,8 - 1,0	
	Al.Mg	0,8 - 1,0 - 1,2		0,8 - 1,0 - 1,2	
	Al.Si	0,8 - 1,0 - 1,2		1,0 - 1,2	
	Cu.Si 3 / Cu.Al 8	0,8 - 1,0		0,8 - 1,0	
	Filo animato - Flux cored	0,8 - 0,9 - 1,0 - 1,2		0,8 - 0,9 - 1,0 - 1,2	
Bobina ø mm - Wire spool ø mm		200 - 300			
MMA Elettrodi - Electrodes : ø mm		1,6 - 4,0			
Connessioni in uscita - Output connection		DX 25 mmq		DX 50 mmq	
Peso - Weight ≈		30 kg		30 kg	
Dimensioni - Dimensions		777 x 407 x 792 mm		777 x 407 x 792 mm	
Codice - Code		247000		247100	

Caratteristiche

- Amperometro, Voltmetro.
- Cambio polarità per fili aminati.
- Trainafilo 2 rulli.
- Scomparto porta attrezzi.

Funzioni MIG

- Saldatura sinergica.
- Induttanza elettronica.
- Hot Start: Regolabile.
- Burn back.

Funzioni MMA

- Hot Start.
- Arc Force: Regolabile.
- Anti-sticking.

Funzioni TIG

- **TIG DC:** Torcia con rubinetto ed innesco LIFT.
- Anti-sticking.
- Slope down regolabile.

Features

- Ammeter, Voltmeter.
- Reversed polarity for flux cored wires.
- 2 rolls wire feeder.
- Tools compartment.

MIG Features

- Synergic welding.
- Electronic inductance.
- Adjustable Hot Start.
- Burn back.

MMA Features

- Hot Start.
- Adjustable Arc Force.
- Anti-sticking.

TIG Features

- **Tig DC:** Torch with gas valve and Lift ignition.
- Anti-sticking.
- Adjustable Slope down.

Easy Job 520: accessori in dotazione - Supplied accessories:

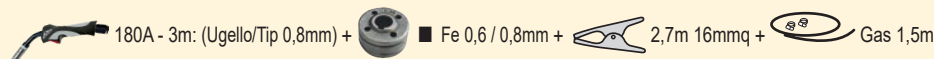

Easy Job 525E: accessori in dotazione - Supplied accessories:

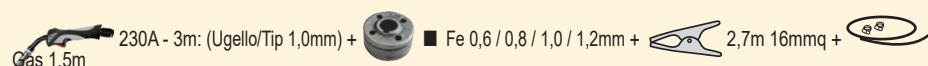

Accessori - Accessories MIG / MAG pag.104

Optional and Consumable							
Animato / Flux 0,9 2,0kg 010816 (Fe) Acciaio / Steel 0,6 5,0kg 010801 0,8 5,0kg 010805 1,0 5,0kg 010846 (AlMg5) Alluminio 1,0 2,0kg 010876 (AlSi) Alluminio 1,0 2,0kg 010860 (CuSi3) Brazing 0,8 2,0kg 010845		EP15 Pistol Grip 180 @ 60% 3 m 010507 4 m 010508		DE 230A 230 @ 60% 3m 010584		Pinza porta elettrodo Electrode holder 300A + 3,0m 35mmq + DX50 010070	EasyJob 525E
Rullino trainafilo Wire roller Flux 0,9/1,0 011218 Flux 1,0/1,2 011219 Fe 1,0/1,2 011215 Al 0,8/1,0 011216 Al 1,0/1,2 011217		EP25 Pistol Grip 230 @ 60% 3 m 010576 4 m 010577		Torcia TIG / TIG Torch TG17 140A - 4m Dx25/50mmq (1,6 WR2 acciaio-steel) 010068		Pinza porta elettrodo Electrode holder 200A + 2,7m 16mmq + DX25 010069	EasyJob 520
Regolatore di pressione + adattatore CO2 <-> Ar (IT / USA) Pressure regulator + adapter CO2 <-> Ar (IT / USA) 010836		Starter kit Alu 1,0mm Guaina / Torch liner Al 1,0/1,2 (010856) + Ugello / Contact tip Al 1,0 3pc (010257) + Rullino / Wire roller Al 1,0/1,2 (011217)		Bacchette TIG / TIG rods L. 100mm Kg 1,0 Inox 308L 011255 Inox 316L 011256 Inox 309L 011257		WM35 TC True Colour / Grinding DIN 5-9 / 9-13 Filtro auto-oscurante a colori reali 100x60mm True colour auto-darkening filter 100x60mm	
		Starter Kit per acciaio Starter Kit for Steel 2,4mm WR2 010072					

JOB 222 PD LAB

MULTIPROCESS MIG / MAG - NO GAS - MMA - TIG INVERTER

NEW!

MIG DOUBLE PULSE

Manutenzione
Maintenance
Carpenteria leggera
Light carpentry
Autoriparazioni
Automotive



Generatore multifunzione top di gamma per la saldatura professionale e saldobrasatura di acciaio ad alta resistenza, acciaio dolce, inossidabile ed alluminio.

- Saldatura: MIG/MAG, FLUX, MMA e TIG Lift
- Pannello di controllo grafico a colori con due modalità di utilizzo: semplice od avanzata.
- DC Sinergica. Tutti i principali parametri di saldatura sono collegati e agiscono in maniera combinata.
- MIG pulsato e doppio pulsato per risultati eccezionali su alluminio di basso spessore ed inox.
- Saldobrasatura MIG per acciaio galvanizzato.
- Inversione della polarità: per saldare con fili animati.
- Pacchetto programmi standard per oltre 20 tipologie di materiale, diametro e gas.
- Memoria digitale per salvare le impostazioni preferite.
- Aggiornamento software tramite SD-Card.

Top-class multiprocess welding machine for professional welding and MIG brazing of high-tensile steel, mild steel, stainless steel and aluminum.

- Welding processes: MIG/MAG, FLUX, MMA, TIG Lift.
- Multicolor graphic display with 2 modes: basic or advanced.
- Synergic DC. All the primary welding parameters are linked and work together.
- Pulse MIG and double pulse MIG to achieve excellent results on welding low thickness aluminum and stainless steel.
- MIG brazing process for galvanised steel.
- Polarity reversal: for welding with flux cored wires.
- Standard package of 20+ types of material, wire diameters and gases.
- Digital memory: to save one's favourite welding settings.
- Software update via SD-Card.

SPECIALE GENERATORE
GENERATOR USE

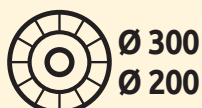

15 kg MAX

Multilingua / Multilanguage



Selezione del processo di saldatura
Selection of the welding process

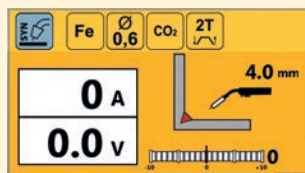

Cruscotto saldatura MIG sinergica
Synergic MIG welding dashboard

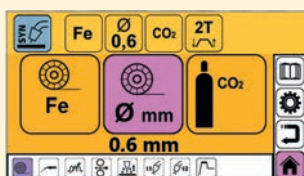

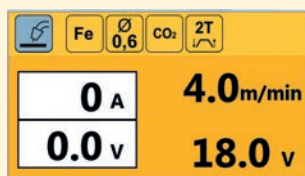

Regolazione della sinergia MIG
MIG synergy setting

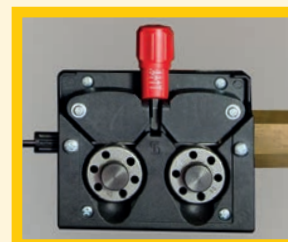

Cruscotto saldatura MIG manuale
Manual MIG welding dashboard



Trainafile 4 rulli D.37mm
4 rolls wire feeder D.37mm

				JOB 222 PD LAB	
Tensione di alimentazione - Input voltage		1 ph - 230V - 50/60 Hz			
Potenza assorbita - Absorbed power: 60% / Max		3,3 / 6,3 kW			
Fusibile - Fuse		25A			
Generatore - Generator		+/- 30% (9 kW)			
Rendimento - Efficiency		> 80%			
		MIG / TIG		MMA	
Campo di regolazione - Welding current range		10 - 220A		10 - 160A	
Corrente DC - Current DC (40°C EN 60974-1)		220A - 20%		160A - 30%	
		140A - 60%		130A - 60%	
Tensione a vuoto - Open circuit voltage		85V			
MIG - MAG Filo - Wires: ø mm	Acciaio - Steel Sg2 Sg3	0,6 - 0,8 - 1,0			
	Inox AISI ER308 / ER316 / ER309	0,8 - 1,0			
	Al.Mg 5	0,8 - 1,0 - 1,2			
	Al.Si 5	1,0 - 1,2			
	Cu.Si 3 / Cu.Al 8	0,8 - 1,0 - 1,2			
	Filo animato - Flux cored	0,6 - 0,9 - 1,2			
Bobina ø mm- Wire spool ø mm		200 - 300			
MMA Elettrodi - Electrodes: ø mm		1,6 - 4,0			
Peso - Weight ≈		14,6 kg			
Dimensioni - Dimensions		556 x 268 x 438 mm			
Codice - Code		250200			

Accessori in dotazione - Supplied accessories:

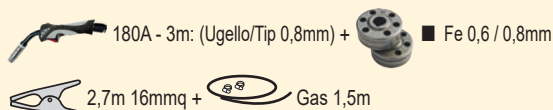

Caratteristiche

- Lettore SD Card.
- Trainafilo 4 rulli.

Funzioni MIG

- Caricamento filo.
- Test gas.
- Funzioni pulsante torcia: 2/4T / Spot / Stitch.
- 16 memorie programmi.
- MIG pulsato e doppio pulsato.
- Induttanza elettronica.
- Pre gas, Post gas regolabili.
- Velocità avvicinamento filo.
- Funzione crater filler.
- Slope up & down regolabili.
- Burn back regolabile.

Funzioni MMA

- Hot Start ed Arc Force regolabili.
- Anti-sticking.

Funzioni TIG

- Tig Lift: Torcia con rubinetto.
- Anti-sticking.
- Slope down regolabile.

Features

- SD Card reader.
- 4 Rolls wire feeder.

MIG Features

- Wire loading.
- Gas test.
- Torch trigger mode: 2/4T / Spot / Stitch.
- 16 programs saving.
- Pulse MIG and double pulse MIG.
- Electronic inductance.
- Adjustable Pre gas, Post gas.
- Wire approach speed.
- Crater filler control.
- Adjustable Slope up & down.
- Adjustable Burn back.

MMA Features









- Adjustable Hot Start.
- Adjustable Arc Force.

Anti-sticking.

TIG Features

- Tig Lift: Torch with gas valve.
- Anti-sticking.
- Adjustable Slope down.

Accessori - Accessories MIG / MAG pag.104

Optional and Consumable							
Animato / Flux 0,9 2,0kg 010816 (Fe) Acciaio / Steel 0,6 5,0kg 010801 0,8 5,0kg 010805 1,0 5,0kg 010846 (AlMg5) Alluminio 1,0 2,0kg 010876 (AlSi) Alluminio 1,0 2,0kg 010860 (CuSi3) Brazing 0,8 2,0kg 010845		EP15 Pistol Grip 18 0@ 60% 3 m 010507 4 m 010508		Torcia TIG / TIG Torch TG17 140A - 4m Dx25/50mmq (1,6 WR2 acciaio-steel) 010068		Pinza porta elettrodo Electrode holder 200A + 2,7m 16mmq + DX25 010069	
Rullino trainafilo Wire roller Flux 0,9/1,0/1,2 011224 Fe 1,0/1,2 011221 Al 0,8/1,0 011222 Al 1,0/1,2 011223		Starter kit Alu 1,0mm Guaina / Torch liner Al 1,0/1,2 (010856) + Ugello /Contact tip Al 1,0 3pc (010257) + Rullino /Wire roller Al 1,0/1,2 (011223)		Bacchette TIG / TIG rods L. 1000mm Kg 1,0 Inox 308L 1,6mm 011255 Inox 316L 1,6mm 011256 Inox 309L 1,6mm 011257		WM35 TC True Colour / Grinding DIN 5-9 / 9-13 Filtro auto-oscurante a colori reali 100x60mm True colour auto-darkening filter 100x60mm	
Regolatore di pressione + adattatore CO2 + Ar (IT / USA) Pressure regulator + adapter CO2 <-> Ar (IT / USA) 010836		010851					

JOB 522 PD LAB

MULTIPROCESS MIG / MAG - NO GAS - MMA - TIG INVERTER

NEW!

MIG DOUBLE PULSE

Manutenzione
Maintenance
Carpenteria leggera
Light carpentry
Autoriparazioni
Automotive

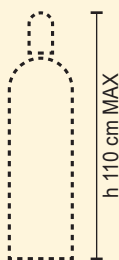

**RUOTE INDUSTRIALI
HEAVY DUTY WHEELS**

**VANO PORTA ATTREZZI
TOOLS COMPARTMENT**

Multilingua / Multilanguage



Generatore multifunzione top di gamma studiato per la saldatura professionale e saldobrasatura di acciaio ad alta resistenza, acciaio dolce, inossidabile ed alluminio.

- Saldatura: MIG/MAG, FLUX, MMA e TIG Lift
- Pannello di controllo grafico a colori con due modalità di utilizzo: semplice od avanzata.
- DC Sinergica. Tutti i principali parametri di saldatura sono collegati e agiscono in maniera combinata.
- MIG pulsato e doppio pulsato per risultati eccezionali su alluminio di basso spessore ed inox.
- Saldobrasatura MIG per acciaio galvanizzato.
- Inversione della polarità: per saldare con fili animati.
- Pacchetto programmi standard per oltre 20 tipologie di materiale, diametro e gas.
- Memoria digitale per salvare le impostazioni preferite.
- Aggiornamento software tramite SD-Card.

Top-class multiprocess welding machine for professional welding and MIG brazing of high-tensile steel, mild steel, stainless steel and aluminum.

- Welding processes: MIG/MAG, FLUX, MMA, TIG Lift.
- Multicolor graphic display with 2 modes: basic or advanced.
- Synergic DC. All the primary welding parameters are linked and work together.
- Pulse MIG and double pulse MIG to achieve excellent results on welding low thickness aluminum and stainless steel.
- MIG brazing process for galvanised steel.
- Polarity reversal: for welding with flux cored wires.
- Standard package of 20+ types of material, wire diameter and gas.
- Digital memory: to save one's favourite welding settings.
- Software update via SD-Card.



Selezione del processo di saldatura
Selection of the welding process

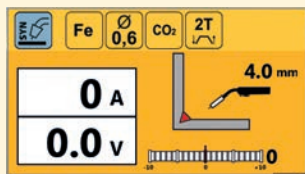

Cruscotto saldatura MIG sinergica
Synergic MIG welding dashboard

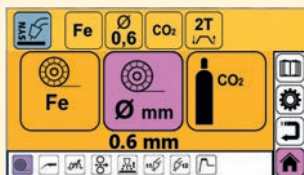

Regolazione della sinergia MIG
MIG synergy setting

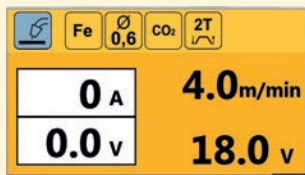



Cruscotto saldatura MIG manuale
Manual MIG welding dashboard

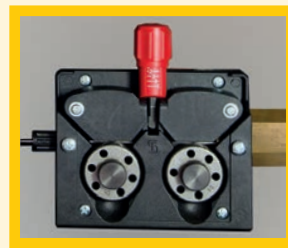

Supporto torcia
Torch holder



Trainafilo 4 rulli D.37mm
4 rolls wire feeder D.37mm

				JOB 522 PD LAB	
Tensione di alimentazione - Input voltage		1 ph - 230V - 50/60 Hz			
Potenza assorbita - Absorbed power: 60% / Max		3,3 / 6,3 kW			
Fusibile - Fuse		25A			
Generatore - Generator		+/- 30% (9 kW)			
Rendimento - Efficiency		> 80%			
		MIG / TIG		MMA	
Campo di regolazione - Welding current range		10 - 220A		10 - 160A	
Corrente DC - Current DC (40°C EN 60974-1)		220A - 20%		160A - 30%	
		140A - 60%		130A - 60%	
Tensione a vuoto - Open circuit voltage		85V			
MIG - MAG Filo - Wires: ø mm	Acciaio - Steel Sg2 Sg3	0,6 - 0,8 - 1,0			
	Inox AISI ER308 / ER316 / ER309	0,8 - 1,0			
	Al.Mg 5	0,8 - 1,0 - 1,2			
	Al.Si 5	1,0 - 1,2			
	Cu.Si 3 / Cu.Al 8	0,8 - 1,0 - 1,2			
	Filo animato - Flux cored	0,6 - 0,9 - 1,2			
Bobina ø mm - Wire spool ø mm		200 - 300			
MMA Elettrodi - Electrodes: ø mm		1,6 - 4,0			
Peso - Weight ≈		30 kg			
Dimensioni - Dimensions		777 x 407 x 792 mm			
Codice - Code		250500			

Accessori in dotazione - Supplied accessories:

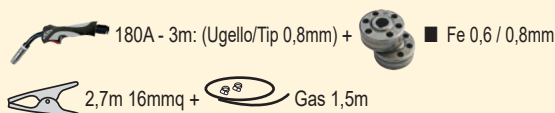

Caratteristiche

- Lettore SD Card.
- Trainafilo 4 rulli.

Funzioni MIG

- Caricamento filo.
- Test gas.
- Funzioni pulsante torcia: 2/4T / Spot / Stitch.
- 16 memorie programmi.
- MIG pulsato e doppio pulsato.
- Induttanza elettronica.
- Pre gas, Post gas regolabili
- Velocità avvicinamento filo.
- Funzione crater filler.
- Slope up & down regolabili.
- Burn back regolabile.

Funzioni MMA

- Hot Start regolabile.
- Arc Force regolabile.
- Anti-sticking.

Funzioni TIG

- Tig Lift: Torcia con rubinetto.
- Anti-sticking.
- Slope down regolabile.

Features

- SD Card reader.
- 4 Rolls wire feeder.

MIG Features

- Wire loading.
- Gas test.
- Torch trigger mode: 2/4T / Spot / Stitch.
- 16 programs saving.
- Pulse MIG and double pulse MIG.
- Electronic inductance.
- Adjustable Pre gas, Post gas
- Wire approach speed.
- Crater filler control
- Adjustable Slope up & down.
- Adjustable Burn back.











MMA Features

- Adjustable Hot Start.
- Adjustable Arc Force.
- Anti-sticking.

TIG Features

- Tig Lift: Torch with gas valve.
- Anti-sticking.
- Adjustable Slope down.

Accessori - Accessories MIG / MAG pag.104

Optional and Consumable							
■ Animato / Flux 0,9 2,0kg 010816 ■ (Fe) Acciaio / Steel 0,6 5,0kg 010801 0,8 5,0kg 010805 1,0 5,0kg 010846 ■ (AlMg5) Alluminio 1,0 2,0kg 010876 ■ (AlSi) Alluminio 1,0 2,0kg 010860 ■ (CuSi3) Brazing 0,8 2,0kg 010845		EP15 Pistol Grip 180 @ 60% 3 m 010507 4 m 010508		DE 230A 230 @ 60% 3m 010584		Starter Kit per acciaio Starter Kit for Steel 2,4mm WR2 010072	
		EP25 Pistol Grip 230 @ 60% 3 m 010576 4 m 010577		Torcia TIG / TIG Torch TG17 140A - 4m Dx25/50mmq (1,6 WR2 acciaio-steel) 010068		Pinza porta elettrodo Electrode holder 200A + 2,7m 16mmq + DX25 010069	
Rullino trainafilo Wire roller ■ Flux 0,9/1,0/1,2 011224 ■ Fe 1,0/1,2 011221 ■ Al 0,8/1,0 011222 ■ Al 1,0/1,2 011223		Starter kit Alu 1,0mm Guaina / Torch liner Al 1,0/1,2 (010856) + Ugello /Contact tip Al 1,0 3pc (010257) + Rullino /Wire roller Al 1,0/1,2 (011223)		Bacchette TIG / TIG rods L. 1000mm Kg 1,0 Inox 308L 1,6mm 011255 Inox 316L 1,6mm 011256 Inox 309L 1,6mm 011257		WM35 TC True Colour / Grinding DIN 5-9 / 9-13 Filtro auto-oscurante a colori reali 100x60mm True colour auto-darkening filter 100x60mm	
Regolatore di pressione + adattatore CO2 <-> Ar (IT / USA) Pressure regulator + adapter CO2 <-> Ar (IT / USA) 010836		010851				010412	

JOB Duo 220

LAB

MULTIPROCESS MIG / MAG - MMA - TIG INVERTER

Autoriparazioni
Car body repair

NEW!



MIG DOUBLE PULSE

Generatore multifunzione top di gamma studiato per la saldatura professionale e saldobrasatura di acciaio ad alta resistenza, acciaio dolce, inossidabile ed alluminio.

- Saldatura: MIG/MAG, MMA e TIG Lift
- Pannello di controllo grafico a colori con due modalità di utilizzo: semplice od avanzata.
- DC Sinergica. Tutti i principali parametri di saldatura sono collegati e agiscono in maniera combinata.
- MIG pulsato e doppio pulsato per risultati eccezionali su alluminio di basso spessore ed inox.
- Saldobrasatura MIG per acciaio galvanizzato.
- Pacchetto programmi standard per oltre 20 tipologie di materiale, diametro e gas.
- Memoria digitale per salvare le impostazioni preferite.
- Aggiornamento software tramite SD-Card.

Top-class multiprocess welding machine for professional welding and MIG brazing of high-tensile steel, mild steel, stainless steel and aluminum.

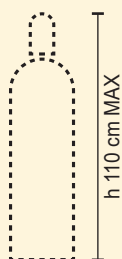
- Welding processes: MIG/MAG, MMA and TIG Lift.
- Multicolor graphic display with 2 modes: basic or advanced.
- Synergic DC. All the primary welding parameters are linked and work together.
- Pulse MIG and double pulse MIG to achieve excellent results on welding low thickness aluminum and stainless steel.
- MIG brazing process for galvanised steel.
- Standard package of 20+ types of material, wire diameter and gas.
- Digital memory: to save one's favourite welding settings.
- Software update via SD-Card.



**Alu
Fe / Brazing**



2 X Ø 300/200

**RUOTE INDUSTRIALI
HEAVY DUTY WHEELS**

Multilingua / Multilanguage



Selezione del processo di saldatura
Selection of the welding process

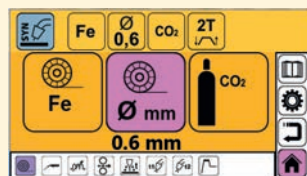

Regolazione della sinergia MIG
MIG synergy setting

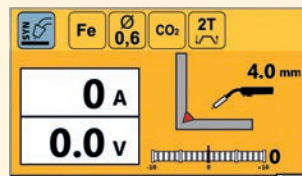

Cruscotto saldatura MIG sinergica
Synergic MIG welding dashboard

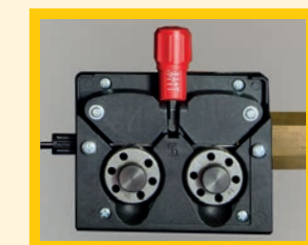

Trainafile 4 rulli D.37mm
4 rolls wire feeder D.37mm

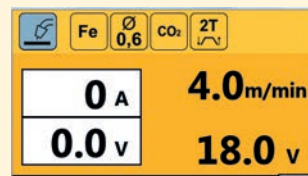

Cruscotto saldatura MIG manuale
Manual MIG welding dashboard

				JOB DUO 220 LAB	
Tensione di alimentazione - Input voltage		1 ph - 230V - 50/60 Hz			
Potenza assorbita - Absorbed power: 60% / Max		3,3 / 6,3 kW			
Fusibile - Fuse		25A			
Generatore - Generator		+/- 30% (9 kW)			
Rendimento - Efficiency		> 80%			
		MIG / TIG		MMA	
Campo di regolazione - Welding current range		10 - 220A		10 - 160A	
Corrente DC - Current DC (40°C EN 60974-1)		220A - 20% 140A - 60%		160A - 30% 130A - 60%	
Tensione a vuoto - Open circuit voltage		85V			
MIG- MAG Filo - Wires: ø mm	Acciaio - Steel Sg2 Sg3	0,6 - 0,8 - 1,0			
	Inox AISI ER308 / ER316 / ER309	0,8 - 1,0			
	Al.Mg 5	0,8 - 1,0 - 1,2			
	Al.Si 5	1,0 - 1,2			
	Cu.Si 3 / Cu.Al 8	0,8 - 1,0 - 1,2			
Bobina ø mm - Wire spool ø mm		200 - 300 X 2			
MMA Elettrodi - Electrodes: ø mm		1,6 - 4,0			
Peso - Weight ≈		48,5 kg			
Dimensioni - Dimensions		860 x 560 x 1000 mm			
Codice - Code		250900			

Accessori in dotazione - Supplied accessories:

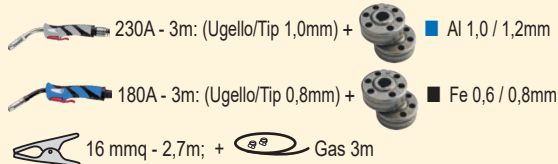
Caratteristiche

- Lettore SD Card.
- Trainafilo 4 rulli.

Funzioni MIG

- Richiamo programma con pulsante torcia.
- Caricamento filo.
- Test gas.
- Funzioni pulsante torcia: 2/4T / Spot / Stitch.
- 16 memorie programmi.
- MIG pulsato e doppio pulsato.
- Induttanza elettronica.
- Pre gas, Post gas regolabili.
- Funzione crater filler
- Slope up & down regolabili.
- Burn back regolabile.

Funzioni MMA

- Hot Start ed Arc Force regolabile.
- Anti-sticking.

Funzioni TIG

- Tig Lift: Torcia con rubinetto.
- Anti-sticking.
- Slope down regolabile.

Predisposizioni:

- Torcia con potenziometro.
- Spool Gun.

Features

- SD Card reader.
- 4 rolls wire feeder.

MIG Features

- Program recall by torch trigger.
- Wire loading.
- Gas test.
- Torch trigger mode: 2/4T / Spot / Stitch.
- 16 programs saving.
- Pulse MIG and double pulse MIG.
- Electronic inductance.
- Adjustable Pre gas, Post gas.
- Crater filler control.
- Adjustable Slope up & down.
- Adjustable Burn back.

MMA Features

- Adjustable Hot Start.
- Adjustable Arc Force.
- Anti-sticking.

TIG Features

- Tig Lift: Torch with gas valve.
- Anti-sticking.
- Adjustable Slope down.

Arranged for:

- Potentiometer torch.
- Spool Gun.

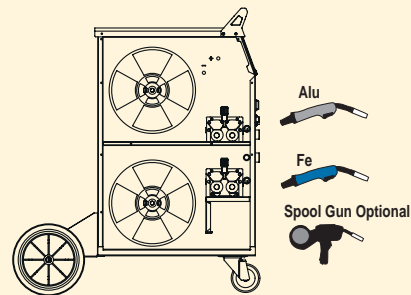

Accessori - Accessories MIG / MAG pag. 104

Optional and Consumable					
■(Fe) Acciaio / Steel 0,6 5,0kg 010801 0,8 5,0kg 010805 1,0 5,0kg 010846 ■(AlMg5) Alluminio 1,0 2,0kg 010876 ■(AlSi) Alluminio 1,0 2,0kg 010860 ■(CuSi3) Brazing 0,8 2,0kg 010845		EP15 Pistol Grip 180 @ 60% 3 m 010507 4 m 010508		Torcia TIG / TIG Torch TG17 140A - 4m Dx25/50mmq (1,6 WR2 acciaio-steel) 010068	Pinza porta elettrodo Electrode holder 200A + 2,7m 16mmq + DX25 010069
		EP25 Pistol Grip 230 @ 60% 3 m 010576 4 m 010577		Starter Kit per acciaio Starter Kit for Steel 2,4mm WR2 010072	Guanti (T10) Gloves (S10) 010963
Rullino trainafilo Wire roller ■Fe 0,6/0,8 011220 ■Fe 1,0/1,2 011221 ■Al 0,8/1,0 011222 ■Al 1,0/1,2 011223		DE 230A 230 @ 60% 3m 010584		Bacchette TIG / TIG rods L. 1000mm Kg 1,0 Inox 308L 011255 Inox 316L 011256 Inox 309L 011257	WM40 TC True Colour / Grinding DIN 5-9 / 9-13 Filtro auto-oscurante a colori reali 100x83mm True colour auto-darkening filter 100x83mm 010414
Regolatore di pressione + adattatore CO2 + Ar (IT / USA) Pressure regulator + adapter CO2 <=> Ar (IT / USA) 010836		Kit comando remoto Remote contro Kit 010568			

MULTIPROCESS MIG / MAG - MMA - TIG INVERTER

Autoriparazioni
Car body repair

NEW!



MIG DOUBLE PULSE

Generatore multifunzione top di gamma studiato per la saldatura professionale e saldobrasatura di acciaio ad alta resistenza, acciaio dolce, inossidabile ed alluminio.

- Saldatura: MIG/MAG, MMA e TIG Lift
- Pannello di controllo grafico a colori con due modalità di utilizzo: semplice od avanzata.
- DC Sinergica. Tutti i principali parametri di saldatura sono collegati e agiscono in maniera combinata.
- MIG pulsato e doppio pulsato per risultati eccezionali su alluminio di basso spessore.
- Saldobrasatura MIG per acciaio galvanizzato.
- Pacchetto programmi standard per oltre 20 tipologie di materiale, diametro e gas.
- Memoria digitale per salvare le impostazioni preferite.
- Aggiornamento software tramite SD-Card.

Top-class multiprocess welding machine for professional welding and MIG brazing of high-tensile steel, mild steel, stainless steel and aluminum.

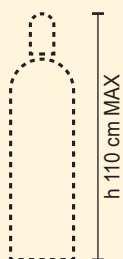
- Welding processes: MIG/MAG, MMA and TIG Lift.
- Multicolor graphic display with 2 modes: basic or advanced.
- Synergic DC. All the primary welding parameters are linked and work together.
- Pulse MIG and double pulse MIG to achieve excellent results on welding low thickness aluminum.
- MIG brazing process for galvanised steel.
- Standard package of 20+ types of material, wire diameter and gas.
- Digital memory: to save one's favourite welding settings.
- Software update via SD-Card.



**Alu
Fe
Brazing**



3 X Ø 200

**RUOTE INDUSTRIALI
HEAVY DUTY WHEELS**

Multilingua / Multilanguage

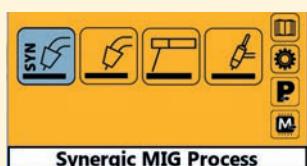

Selezione del processo di saldatura
Selection of the welding process

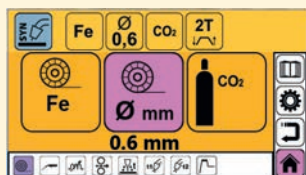

Regolazione della sinergia MIG
MIG synergy setting

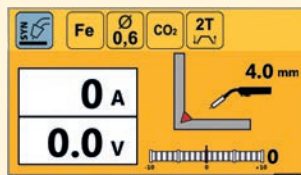

Cruscotto saldatura MIG sinergica
Synergic MIG welding dashboard

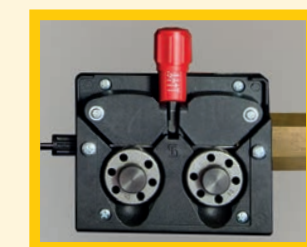

Trainafile 4 rulli D.37mm
4 rolls wire feeder D.37mm

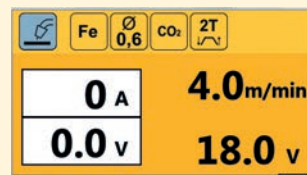

Cruscotto saldatura MIG manuale
Manual MIG welding dashboard

		MADE IN SAN MARINO				JOB TRIO 220 LAB	
Tensione di alimentazione - Input voltage				1 ph - 230V - 50/60 Hz			
Potenza assorbita - Absorbed power: 60% / Max				3,3 / 6,3 kW			
Fusibile - Fuse				25A			
Generatore - Generator				+/- 30% (9 kW)			
Rendimento - Efficiency				> 80%			
				MIG / TIG		MMA	
Campo di regolazione - Welding current range				10 - 220A		10 - 160A	
Corrente DC - Current DC (40°C EN 60974-1)				220A - 20%		160A - 30%	
				140A - 60%		130A - 60%	
Tensione a vuoto - Open circuit voltage				85V			
MIG - MAG Filo - Wires: ø mm		Acciaio - Steel Sg2 Sg3		0,6 - 0,8 - 1,0			
		Inox AISI ER308 / ER316 / ER309		0,8 - 1,0			
		Al.Mg 5		0,8 - 1,0 - 1,2			
		Al.Si 5		1,0 - 1,2			
		Cu.Si 3 / Cu.Al 8		0,8 - 1,0 - 1,2			
Bobina ø mm - Wire spool ø mm				200 X 3			
MMA Electrodi - Electrodes: ø mm				1,6 - 4,0			
Peso - Weight =				50 kg			
Dimensioni - Dimensions				860 x 560 x 1000 mm			
Codice - Code				250600			

Accessori in dotazione - Supplied accessories:

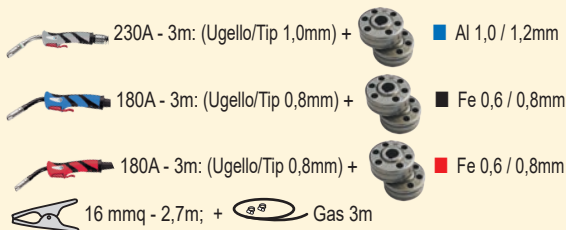
Caratteristiche

- Lettore SD Card.
- Trainafilo 4 rulli.

Funzioni MIG

- Richiamo programma con pulsante torcia.
- Caricamento filo.
- Test gas.
- Funzioni pulsante torcia: 2/4T / Spot / Stitch.
- 16 memorie programmi.
- MIG pulsato e doppio pulsato.
- Induttanza elettronica.
- Pre gas, Post gas regolabili.
- Funzione crater filler
- Slope up & down regolabili.
- Burn back regolabile.

Funzioni MMA

- Hot Start regolabile.
- Arc Force regolabile.
- Anti-sticking.

Funzioni TIG

- Tig Lift: Torcia con rubinetto.
- Anti-sticking.
- Slope down regolabile.

Predisposizioni:

- Torcia con potenziometro.
- Spool Gun.

Features

- SD Card reader.
- 4 Rolls wire feeder.

MIG Features

- Program recall by torch trigger.
- Wire loading.
- Gas test.
- Torch trigger mode: 2/4T / Spot / Stitch.
- 16 programs saving.
- Pulse MIG and double pulse MIG.
- Electronic inductance.
- Adjustable Pre gas, Post gas.
- Crater filler control
- Adjustable Slope up & down.
- Adjustable Burn back.

MMA Features

- Adjustable Hot Start.
- Adjustable Arc Force.
- Anti-sticking.

TIG Features

- Tig Lift: Torch with gas valve.
- Anti-sticking.
- Adjustable Slope down.

Arranged for:

- Potentiometer torch.
- Spool Gun.

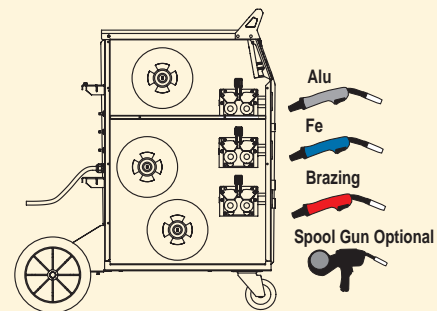

Accessori - Accessories MIG / MAG pag.104

Optional and Consumable

■(Fe) Acciaio / Steel 0,6 5,0kg 010801 0,8 5,0kg 010805 1,0 5,0kg 010846 ■(AlMg5) Alluminio 1,0 2,0kg 010876 ■(AlSi) Alluminio 1,0 2,0kg 010860 ■(CuSi3) Brazing 0,8 2,0kg 010845		EP15 Pistol Grip 180 @ 60% 3 m 010507 4 m 010508		Torcia TIG / TIG Torch TG17 140A - 4m Dx25/50mmq (1,6 WR2 acciaio-steel) 010068		Pinza porta elettrodo Electrode holder 200A + 2,7m 16mmq + DX25 010069	
Rullino trainafilo Wire roller ■Fe 0,6/0,8 011220 ■Fe 1,0/1,2 011221 ■Al 0,8/1,0 011222 ■Al 1,0/1,2 011223		EP25 Pistol Grip 230 @ 60% 3 m 010576 4 m 010577		Starter Kit per acciaio Starter Kit for Steel 2,4mm WR2 010072		Guanti (T10) Gloves (S10) 010963	
Regolatore di pressione + adattatore CO2 + Ar (IT / USA) Pressure regulator + adapter CO2 <-> Ar (IT / USA) ■ ■ ■ 010836		DE 230A 230 @ 60% 3m 010584		Bacchette TIG / TIG rods L. 1000mm Kg 1,0 Inox 308L 011255 Inox 316L 011256 Inox 309L 011257		WM40 TC True Colour / Grinding DIN 5-9 /9-13 Filtro auto-oscurante a colori reali 100x83mm True colour auto- darkening filter 100x83mm 010414	
Kit comando remoto Remote contro Kit 010568		Aspo Spool holder Ø 100 010399		Filtro auto-oscurante a colori reali 100x83mm True colour auto- darkening filter 100x83mm 010414		Pressure regulator + adapter CO2 <-> Ar (IT / USA) ■ ■ ■ 010836	

JOB 635 LAB

MULTIPROCESS MIG / MAG - MMA - TIG INVERTER 3PH

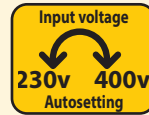

Manutenzione
Maintenance
Carpenteria leggera
Light carpentry
Carpenteria pesante
Heavy carpentry

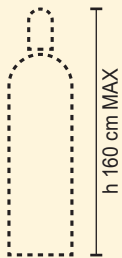
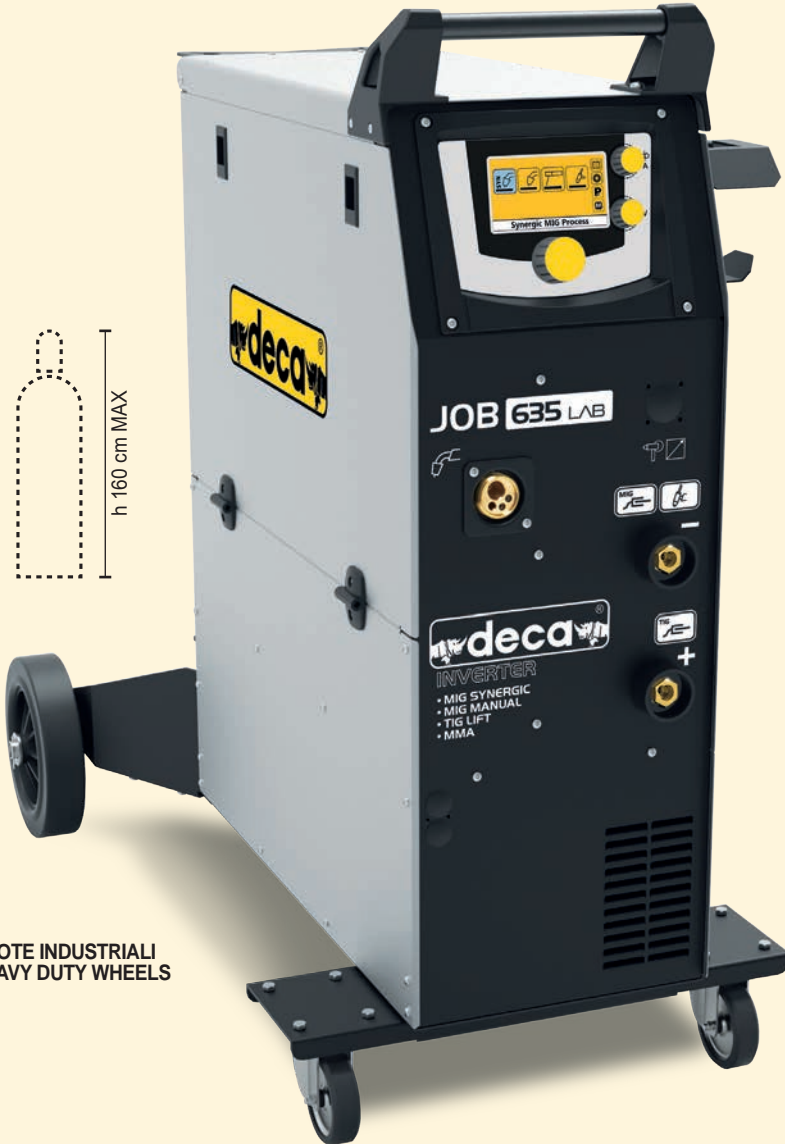

RUOTE INDUSTRIALI
HEAVY DUTY WHEELS

Saldatrice trifase inverter multiprocesso ad alte prestazioni. Ideale per i saldatori che richiedono semplicità nella saldatura avanzata.

- Saldatura: MIG/MAG, MMA e TIG Lift.
- DC Sinergica. Tutti i parametri principali di saldatura sono collegati e agiscono in maniera combinata.
- Pannello di controllo grafico a colori con due modalità di utilizzo: semplice od avanzata.
- Pacchetto programmi standard di oltre 20 programmi per acciaio dolce, inox ed alluminio.
- Memoria digitale per salvare le impostazioni di saldatura preferite.
- Aggiornamento software tramite SD-Card.

High-performance multiprocess three-phase inverter welding machine. Ideal for welders who demand simplicity in advanced welding.

- Welding processes: MIG/MAG, MMA and TIG Lift
- Synergic DC. All the primary welding parameters are linked and work together.
- Multicolor graphic display with 2 modes: basic or advanced.
- Standard package of 20+ welding programs for mild steel, stainless steel and aluminum.
- Digital memory: to save one's favourite welding settings.
- Software update via SD-Card.



Supporto torcia
Torch holder

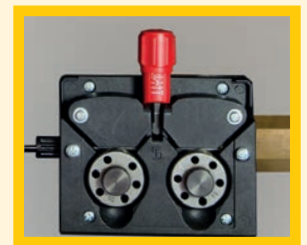

Trainafile 4 rulli D.37mm
4 rolls wire feeder D.37mm

Multilingua / Multilanguage



Selezione del processo di saldatura
Selection of the welding process

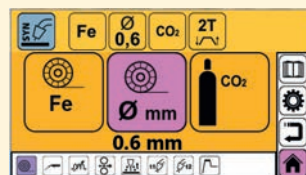

Regolazione della sinergia MIG
Setting MIG synergy

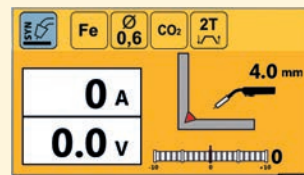

Cruscotto saldatura MIG sinergica
Synergic MIG welding dashboard

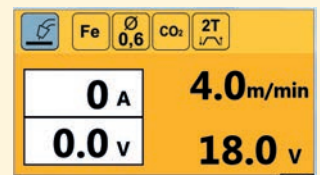

Cruscotto saldatura MIG manuale
Manual MIG welding dashboard



MADE IN SAN MARINO



JOB 635 LAB

Tensione di alimentazione - Input voltage (autosetting)	3ph 400V ± 15% 50/60Hz	3ph 230V ± 15% 50/60Hz
Potenza assorbita - Absorbed power: 60% / Max	7 / 10 kW	5,5 / 7 kW
Fusibile - Fuse	16A	16A
Generatore - Generator	+/- 15% (15 kW)	+/- 15% (10 kW)
Rendimento - Efficiency	> 85%	> 85%
Campo di regolazione - Welding current range	10 - 330A	10 - 260A
Corrente DC - Current DC (40°C EN 60974-1)	300A - 35% (MMA 250A)	230A - 30% (MMA 200A)
	250A - 60% (MMA 220A)	200A - 60% (MMA 170A)
Tensione a vuoto - Open circuit voltage	61V	58V
MIG - MAG Filo - Wires: ø mm	Acciaio - Steel Sg2 Sg3	0,6 - 0,8 - 1,0 - 1,2
	Inox AISI ER308 / ER316 / ER309	0,8 - 1,0
	Al.Mg 5	0,8 - 1,0 - 1,2
	Al.Si 5	1,0 - 1,2
	Cu.Si 3 / Cu.Al 8	0,8 - 1,0 - 1,2
	Filo animato - Flux cored	1,2
Riporti - Hard facing	1,2	
Bobina Ø mm - Wire spool Ø mm	200 - 300	
MMA Elettrodi - Electrodes: ø mm	1,6 - 5,0	
Peso - Weight ≈	46,0 kg	
Dimensioni - Dimensions	984 x 556 x 948 mm	
Codice - Code	263900	

Accessori in dotazione - Supplied accessories:

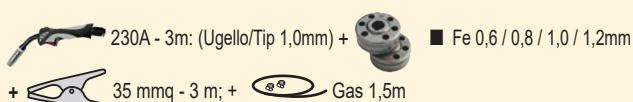

Accessori - Accessories MIG / MAG pag.104

Optional and Consumable						
■(Fe) Acciaio / Steel 0,6 5,0kg 010801 0,8 5,0kg 010805 1,0 5,0kg 010846 ■(AlMg5) Alluminio 1,0 2,0kg 010876 ■(AlSi) Alluminio 1,0 2,0kg 010860 ■(CuSi3) Brazing 0,8 2,0kg 010845		EP25 Pistol Grip 230 @ 60% 3 m 010576 4 m 010577		Torcia TIG / TIG Torch TG17 140A - 4m Dx 50mmq (1,6 WR2 acciaio-steel) 010825	Pinza porta elettrodo Electrode holder 300A + 3,0m 35mmq + DX50 010070	
		EP36 Pistol Grip 330 @ 60% 3 m 010578 4 m 010579		Starter Kit per acciaio Starter Kit for Steel 2,4mm WR2 010072	Kit comando remoto Remote control Kit 010739	
Rullino trainafilo Wire roller ■Flux 0,9/1,0/1,2 011224 ■Al 0,8/1,0 011222 ■Al 1,0/1,2 011223		Starter kit Alu 1,0/1,2mm Guaina / Torch liner Al 1,0/1,2 (010856) + Ugello /Contact tip Al 1,2 20pc M6 (010993) Al 1,2 20pc M8 (010995) + Rullino /Wire roller Al 1,0/1,2 (011223)		Bacchette TIG / TIG rods L. 1000mm Kg 1,0 Inox 308L 1,6mm 011255 Inox 316L 1,6mm 011256 Inox 309L 1,6mm 011257	WM40 TC True Colour / Grinding DIN 5-9 /9-13 Filtro auto-oscurante a colori reali 100x83mm True colour auto- darkening filter 100x83mm	
Regolatore di pressione + adattatore CO2 ↔ Ar (IT / USA) Pressure regulator + adapter CO2 ↔ Ar (IT / USA) 010836		010853				

Caratteristiche

- Lettore SD Card.
- Trainafilo 4 rulli.

Funzioni MIG

- Caricamento filo.
- Test gas.
- Funzioni pulsante torcia: 2/4T / Spot / Stitch.
- Induttanza elettronica.
- Passata di radice.
- Pre gas, Post gas regolabili.
- Hot Start regolabile.
- Velocità avvicinamento filo.
- Slope up & down regolabili.
- Crater filler.
- Burn back regolabile.

Funzioni MMA

- Hot Start regolabile.
- Arc Force regolabile.
- Anti-sticking.

Funzioni TIG

- Tig Lift: torcia con rubinetto.
- Anti-sticking.
- Slope down: Regolabile.

Predisposizioni:

- Torcia con potenziometro.
- Torcia Push Pull.
- Comando a distanza.

Features

- SD Card reader.
- 4 Rolls wire feeder.

MIG Features

- Wire loading.
- Gas purge.
- Torch trigger mode: 2/4T / Spot / Stitch.
- Electronic inductance.
- Root pass.
- Adjustable Pre gas, Post gas.
- Adjustable Hot Start.
- Wire approach speed.
- Adjustable Slope up & down.
- Crater filler.
- Adjustable Burn back.

MMA Features

- Adjustable Hot Start.
- Adjustable Arc Force.
- Anti-sticking.

TIG Features

- Tig Lift: Torch with gas valve.
- Anti-sticking.
- Adjustable Slope down

Arranged for:

- Potentiometer torch.
- Push Pull Torch.
- Remote control.

MULTIPROCESS MIG / MAG - MMA - TIG INVERTER 3PH

NEW!

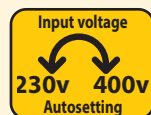

Manutenzione
Maintenance
Carpenteria leggera
Light carpentry
Carpenteria pesante
Heavy carpentry

Saldatrice trifase inverter multiprocesso ad alte prestazioni. Ideale per i saldatori che richiedono semplicità nella saldatura avanzata.

- Saldatura: MIG/MAG, MMA e TIG Lift.
- DC Sinergica. Tutti i parametri principali di saldatura sono collegati e agiscono in maniera combinata.
- Pannello di controllo grafico a colori con due modalità di utilizzo: semplice od avanzata.
- Pacchetto programmi standard di oltre 20 programmi per acciaio dolce, inox alluminio.
- Memoria digitale per salvare le impostazioni di saldatura preferite.
- Aggiornamento software tramite SD-Card.

High-performance multiprocess three-phase inverter welding machine. Ideal for welders who demand simplicity in advanced welding.

- Welding processes: **MIG/MAG, MMA and TIG Lift**
- Synergic DC. All the primary welding parameters are linked and work together.
- Multicolor graphic display with 2 modes: basic or advanced.
- Standard package of 20+ welding programs for mild steel, stainless steel and aluminum.
- Digital memory: to save one's favourite welding settings.
- Software update via SD-Card.

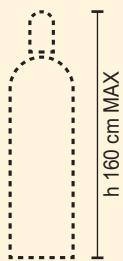

**RUOTE INDUSTRIALI
HEAVY DUTY WHEELS**

Multilingua / Multilanguage



Selezione del processo di saldatura
Selection of the welding process

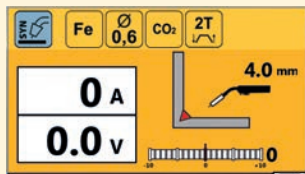

Cruscotto saldatura MIG sinergica
Synergic MIG welding dashboard

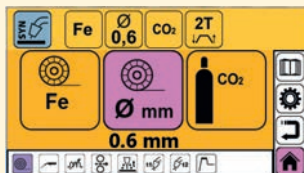

Regolazione della sinergia MIG
Setting MIG synergy

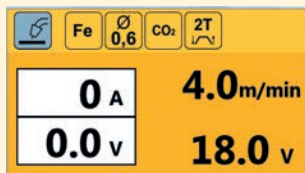

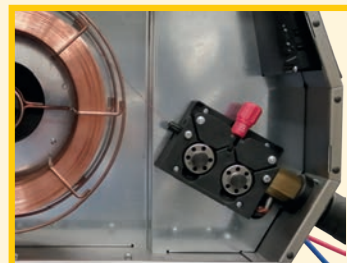

Cruscotto saldatura MIG manuale
Manual MIG welding dashboard

Trainafile 4 rulli D.37mm
4 rolls wire feeder D.37mm



Gruppo raffreddamento integrato (optional)
Integrated water cooling unit (on request)

	MADE IN SAN MARINO		JOB 735 LAB	
Tensione di alimentazione - Input voltage (autosetting)		3ph 400V ± 15% 50/60Hz	3ph 230V ± 15% 50/60Hz	
Potenza assorbita - Absorbed power: 60% / Max		7 / 10 kW	5,5 / 7 kW	
Fusibile - Fuse		16A	16A	
Generatore - Generator		+/- 15% (15 kW)	+/- 15% (10 kW)	
Rendimento - Efficiency		> 85%	> 85%	
Campo di regolazione - Welding current range		10 - 330A	10 - 260A	
Corrente DC - Current DC (40°C EN 60974-1)		300A - 35% (MMA 250A)	230A - 30% (MMA 200A)	
		250A - 60% (MMA 220A)	200A - 60% (MMA 170A)	
Tensione a vuoto - Open circuit voltage		61V	58V	
MIG - MAG Filo Wires: Ø mm	Acciaio - Steel Sg2 Sg3	0,6 - 0,8 - 1,0 - 1,2		
	Inox AISI ER308 / ER316 / ER309	0,8 - 1,0		
	Al.Mg 5	0,8 - 1,0 - 1,2		
	Al.Si 5	1,0 - 1,2		
	Cu.Si 3 / Cu.Al 8	0,8 - 1,0 - 1,2		
	Filo animato - Flux cored	1,2		
	Riporti - Hard facing	1,2		
Bobina Ø mm - Wire spool Ø mm		200 - 300		
MMA Elettrodi - Electrodes: Ø mm		1,6 - 5,0		
Trainafile - Wire feeder: Peso - Weight ≈		18,5 kg		
Trainafile - Wire feeder: Dimensioni - Size		610 x 320 x 565 mm		
Generatore - Power source: Peso - Weight ≈		50 kg		
Generatore - Power source: Dimensioni - Size		984 x 556 x 992 mm		

Accessori in dotazione - Supplied accessories:

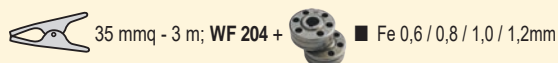

Caratteristiche

- Lettore SD Card.
- Trainafile 4 rulli.

Funzioni MIG

- Caricamento filo.
- Test gas.
- Funzioni pulsante torcia: 2T / 4T / Spot / Stitch.
- Induttanza elettronica.
- Passata di radice.
- Pre gas, Post gas regolabili.
- Hot Start: Regolabile.
- Velocità avvicinamento filo.
- Slope up & down regolabili.
- Crater filler.
- Burn back: Regolabile.

Funzioni MMA

- Hot Start regolabile.
- Arc Force regolabile.
- Anti-sticking.

Funzioni TIG

- Tig Lift torcia con rubinetto.
- Anti-sticking.
- Slope down regolabile.

Predisposizioni:

- Raffreddamento torcia integrato
- Torcia con potenziometro.
- Torcia Push Pull.
- Comando a distanza.

Features

- SD Card reader.
- 4 Rolls wire feeder.

MIG Features

- Wire loading.
- Gas test.
- Torch trigger mode: 2T / 4T / Spot / Stitch.
- Electronic inductance.
- Root pass.
- Adjustable Pre gas, Post gas.
- Adjustable Hot Start.
- Wire approach speed.
- Adjustable Slope up & down.
- Crater filler.
- Adjustable Burn back.

MMA Features

- Adjustable Hot Start.
- Adjustable Arc Force.
- Anti-sticking.

TIG Features







- Tig Lift: Torch with gas valve.
- Anti-sticking.
- Adjustable Slope down.

Arranged for:

- Integrated torch cooling
- Potentiometer torch.
- Push Pull Torch.
- Remote control.

						
Codice - Code						
KIT JOB 735 LAB: (264700 + 264800 + 1,5m AIR)	265400 (264700)	(264800)	1,5m AIR	-	4,0m AIR 010544 9,0m AIR 010545	EP 36 - 3m 330A @ 60 010578 EP 36 - 4m 330A @ 60 010579
KIT JOB 735 LAB H2O READY: (264700 + 264800 + 1,5m H2O + 010602)	265600 (264700)	(264800)	1,5m H2O	(010602)	4,0m H2O 010546 9,0m H2O 010547	EP 500A H2O - 3m 500A @ 100 010580 EP 500A H2O - 4m 500A @ 100 010581

Accessori - Accessories MIG / MAG pag.104

Optional and Consumable					
Rullino trainafile Wire roller Flux 0,9/1,0/1,2 011224 Al 0,8/1,0 011222 Al 1,0/1,2 011223		Regolatore di pressione + adattatore CO2 <=> Ar (IT / USA) Pressure regulator + adapter CO2 <=> Ar (IT / USA) 010836		Pinza porta elettrodo Electrode holder 300A + 3,0m 35mmq + DX50 010314	
Kit sospensione trainafile Kit for wire feeder lift 010704		Torcia TIG / TIG Torch TG17 140A - 4m Dx 50mmq (1,6 WR2 acciaio-steel) 010825		Kit comando remoto Remote control Kit 010739	

SOON 2023

Manutenzione
Maintenance

Carpenteria leggera
Light carpentry

Carpenteria pesante
Heavy carpentry

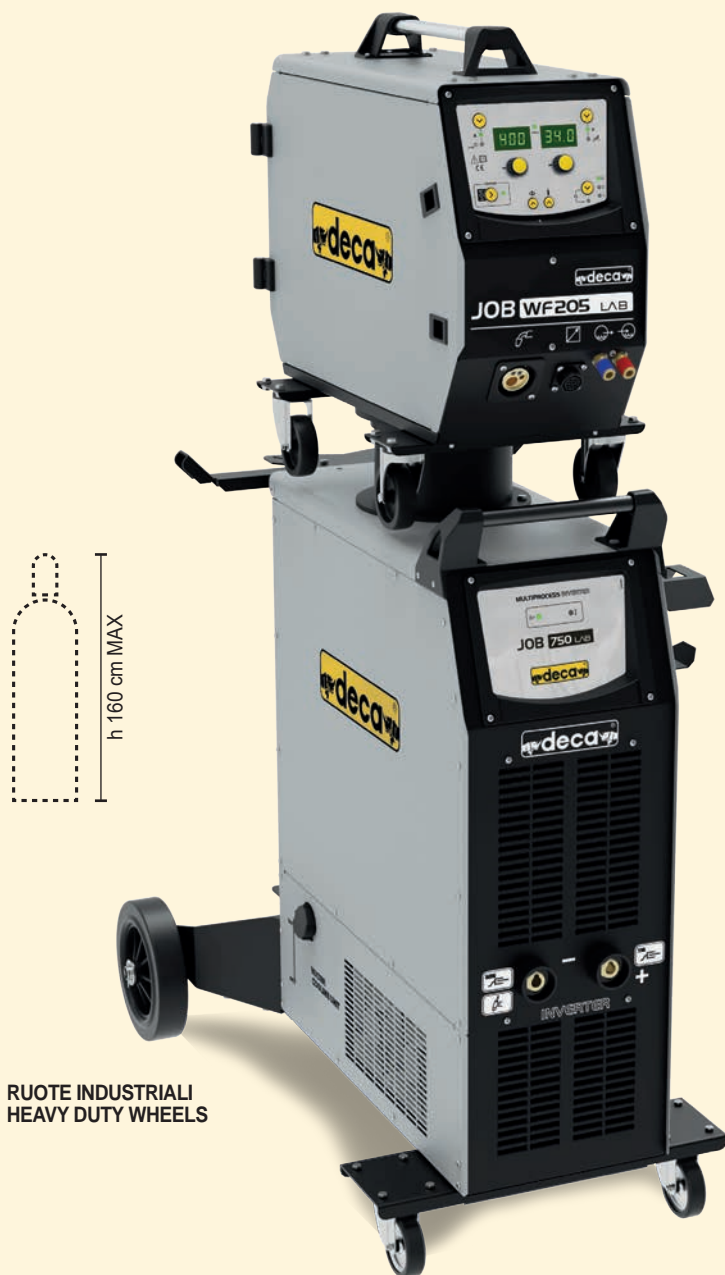

RUOTE INDUSTRIALI
HEAVY DUTY WHEELS

JOB 750 LAB è una saldatrice professionale ad inverter trifase con carrello trainafilo separato per la saldatura in modalità MIG/MAG Short e Spray arc di materiali come acciaio al carbonio, acciaio inox e alluminio.

La disponibilità di ulteriori processi come MMA e TIG, rende questa saldatrice una vera e propria Multifunzione; ideale per i saldatori che richiedono semplicità nella saldatura avanzata.

JOB 750 offre la risposta giusta per tutte le esigenze. L'interfaccia semplice e facile da regolare unita a tutti i processi di saldatura disponibili fanno di JOB 750 uno strumento universale per ogni tipo di produzione.

- Il controllo digitale SIMPLE WELD guida l'operatore nella scelta dell'impostazione corretta della saldatura. Una volta selezionato il programma, determina i parametri di saldatura ottimali per il materiale, il diametro del filo ed il gas utilizzato
- Job 750 è completa dell'unità di raffreddamento interna al generatore.

Job 750 LAB is a professional synergic three-phase Inverter power source with separated wire feeder for MIG/MAG short and spray welding of different materials such as standard steels, inox and aluminum.

The further processes such as MMA and TIG makes this welding machine a real Multifunction; It is ideal for welders who require simplicity in advanced welding.

JOB 750 offers the right answer for all welding requirements. The simple and easy to adjust interface, combined with all available welding processes make the JOB 750 a universal tool for any type of production.

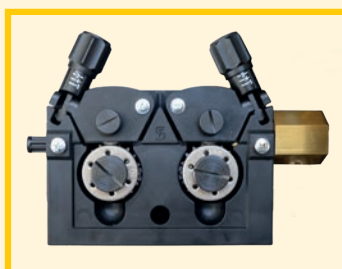
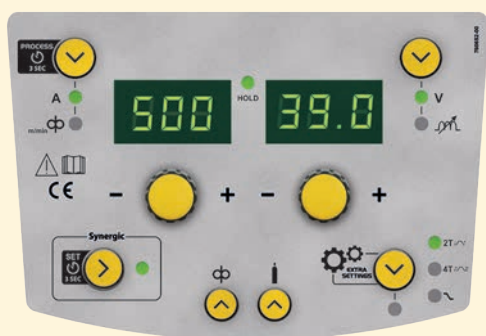

- The digital control SIMPLE WELD allow the operator to easily adjust all welding parameters. Once selected the program its determines the best parameters based on the material type, wire diameter and gas being used,
- Job 750 comes fitted with integrated water cooling unit.



Trainafilo 4 rulli D.37mm
4 rolls wire feeder D.37mm



Gruppo raffreddamento integrato
Integrated water cooling unit

 MADE IN SAN MARINO				JOB 750 LAB	
Tensione di alimentazione - Input voltage (autosetting)		3ph 400V ± 15% 50/60Hz			
Potenza assorbita - Absorbed power: 60% / Max		18 / 22 kW			
Fusibile - Fuse		32A			
Generatore - Generator		+/- 15% 33 kW			
Rendimento - Efficiency		> 85%			
Campo di regolazione - Welding current range		10 - 500A			
Corrente DC - Current DC (40°C EN 60974-1)		500A - 35% (MMA TIG 500A) 430A - 60% 390A - 100%			
Tensione a vuoto - Open circuit voltage		62V			
MIG- MAG Filo - Wires: ø mm	Acciaio - Steel Sg2 Sg3	0,6 - 0,8 - 1,0 - 1,2 - 1,6			
	Inox AISI ER308 / ER316 / ER309	0,8 - 1,0 - 1,2 - 1,6			
	Al.Mg 5	1,0 - 1,2 - 1,6			
	Al.Si 5	1,0 - 1,2 - 1,6			
	Flux metal cored	1,2			
	Flux cored	1,2			
Bobina Ø mm - Wire spool Ø mm		200 - 300			
MMA Elettrodi - Electrodes: ø mm		1,6 - 5,0			
Trainafile - Wire feeder: Peso - Weight ≈		20 kg			
Trainafile - Wire feeder: Dimensioni - Size		610 x 320 x 565 mm			
Generatore - Power source: Peso - Weight ≈		71 Kg			
Generatore - Power source: Dimensioni - Size		984 x 556 x 992 mm			

Accessori in dotazione - Supplied accessories:

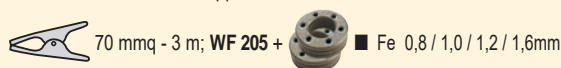

Caratteristiche

- Trainafile 4 rulli.
- Raffreddamento torcia integrato

Funzioni MIG

- Caricamento filo.
- Test gas.
- Funzioni pulsante torcia: 2T 3 livelli / 4T 3 livelli.
- Induttanza elettronica.
- Passata di radice.
- Pre gas, Post gas regolabili.
- Hot Start regolabile.
- Velocità avvicinamento filo.
- Slope up & down regolabili.
- Crater filler.
- Burn back regolabile.

Funzioni MMA

- Hot Start: Regolabile.
- Arc Force: Regolabile.
- Anti-sticking.

Funzioni TIG

- Tig Lift: torcia con rubinetto.
- Anti-sticking.
- Slope up e Slope down regolabili.
- Regolazione tensione di spegnimento arco

Predisposizioni:

- Torcia con potenziometro
- Torcia Push Pull.
- Comando a distanza.

Features

- 4 Rolls wire feeder.
- Integrated torch cooling

MIG Features

- Wire loading.
- Gas test.
- Torch trigger mode: 2T 3 levels / 4T 3 levels
- Electronic inductance.
- Root pass.
- Adjustable Pre gas, Post gas.
- Adjustable Hot Start.
- Wire approach speed.
- Adjustable Slope up & down.
- Crater filler.
- Adjustable Burn back.

MMA Features

- Adjustable Hot Start.
- Adjustable Arc Force.
- Anti-sticking.

TIG Features



- Tig Lift: Torch with gas valve.
- Anti-sticking.
- Adjustable Slope up and Slope down.
- Arc power off voltage regulator

Arranged for:

- Potentiometer torch.
- Push Pull Torch.
- Remote control.

								
Codice - Code								
KIT JOB 750 LAB H2O READY 271800 (265000 + 265200 + 1,5m H2O)	265000	265200	1,5m H2O	H2O	4,0m H2O 9,0m H2O	010588 010831	EP 500A H2O - 3m 500A @ 100 EP 500A H2O - 4m 500A @ 100	010580 010581

Accessori - Accessories MIG / MAG pag.104

Optional and Consumable					
Rullino trainafile Wire roller		Regolatore di pressione + adattatore CO2 <-> Ar (IT / USA) Pressure regulator + adapter CO2 <-> Ar (IT / USA)		Pinza porta elettrodo Electrode holder 300A + 3,0m 35mmq + DX50	
<ul style="list-style-type: none"> ■ Flux 1,0/1,2 011273 ■ Flux 1,2/1,6 011274 ■ Al 1,0/1,2 011272 		<ul style="list-style-type: none"> ■ ■ ■ 010836 		010070	
Kit sospensione trainafile Kit for wire feeder lift		Torcia TIG / TIG Torch TG17 140A - 4m Dx 50mmq (1,6 WR2 acciaio-steel)			
010704		010825			

PAC INVERTER

Manutenzione
Maintenance

Carpenteria leggera
Light carpentry

Carpenteria pesante
Heavy carpentry



SPECIALE GENERATORE GENERATOR USE

INCLUDED!



Taglio al plasma inverter monofase per il taglio manuale su tutti i materiali ferrosi e non ferrosi purchè conduttivi elettricamente: acciaio rame alluminio acciaio inossidabile, ecc.

- Corrente massima di taglio 50A.
- Taglio su acciaio 12 mm, separazione 20mm.
- L'arco di taglio è acceso automaticamente per mezzo dell'arco pilota; questo garantisce una maggiore vita dei consumabili della torcia.
- Taglio su lamiere perforate e la partenza da pieno sono rese possibili dalla tecnologia che commuta dall'arco pilota all'arco di taglio.
- Funzione Scricatura: utile per rimuovere i difetti nel cordone di saldatura, pulire sbavature, ecc.

Single-phase inverter plasma cutter for manual cutting on all ferrous and non-ferrous materials as long as electrically conductive: steel, copper, aluminum, stainless steel, etc.

- Max cutting current 50A.
- Cut on steel 12mm, Severance 20mm.
- The plasma arc is ignited automatically via the pilot arc; this means longer service life of wear parts in the torch body.
- Cutting on perforated or punched plates is possible due to the advanced technology that makes the machine switch between cutting arc and pilot arc.
- Gouging Function: useful to remove lack of fusion in weld seam or to remove burrs from welded parts.





Taglio di qualità fino a 12mm e separazione fino a 20mm
Quality cut up to 12mm and severance up to 20mm

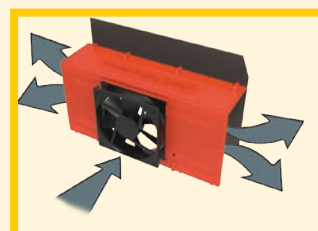

Regolazione aria integrata
Integrated air pressure control



Ventilazione ad alte prestazioni
High performance air cooling

 MADE IN SAN MARINO		I-PAC 350 LAB
Tensione di alimentazione - Input voltage	1 ph - 230V - 50/60 Hz	
Potenza assorbita - Absorbed power: 60% / Max	3,0 / 5,5 kW	
Fusibile - Fuse	20A	
Generatore - Generator	+/- 30% (9kW)	
Rendimento - Efficiency	> 80%	
Taglio / Separazione - Cut / Separation	12 mm / 20 mm	
Corrente di taglio - Cutting current	5 - 50A	
Servizio 40°C - Duty cycle 40°C EN 60974-1	45A - 25%	
	30A - 60%	
	23A - 100%	
Tensione a vuoto - Open circuit voltage	410V	
Pressione aria min/max - Air pressure min/max	3,5 - 5,0 bar	
Consumo aria - Air consumption	130 lt/min	
Innesco taglio - Arc striking	Arco pilota - Pilot arc	
Connettore torcia - Torch connection	Centralizzata - Central connector	
Connettore massa - Earth connection	DX 25 mmq	
Peso - Weight ≈	6,4 kg	
Dimensioni - Dimensions	435 x 160 x 273 mm	
Codice - Code	114800	

Caratteristiche

- Innesco con arco pilota.
- Taglio manuale.
- Taglio su grigliato.
- Scriccatura.
- Torcia con cavo da 4m.
- Ventilazione ad alta efficienza.
- Allerta alimentazione elettrica.
- Allerta protezione termostatica.
- Sistema di sicurezza torcia.
- Alimentazione da rete o da moto generatore.

Features

- Arc striking with pilot arc.
- Manual cutting.
- Cut on grid.
- Gouging.
- 4m cable torch
- High efficiency air cooling.
- Power indicator light.
- Thermostatical protection indicator.
- Safety torch system.
- Power supply from the mains or from motor generator.

Accessori in dotazione - Supplied accessories

 DE50 4m +  2 X Ø 0,8 + 1X 0,9 +  3m; +  Innesco aria - Air connection: 8 / 10 mm

Consumabili torcia / Torch consumables**I-PAC 340**

	Torcia-Torch DE50 4m	010830	
(a)	Porta ugello 6 fori - Nozzle holder 6 holes	010186	4pcs
(b)	Ugello-Nozzleø 0,6 mm 20A	010961	10 pcs
(b)	Ugello-Nozzleø 0,8 mm 30A	010183	10 pcs
(b)	Ugello-Nozzleø 0,9 mm 50A	010123	10 pcs
(b2)	Ugello-Nozzleø 0,9 mm 50A	010185	10 pcs
(b3)	Ugello-NozzleGouging	010525	10 pcs
(c)	Diffusore aria-Swirl	010179	2 pcs
(d)	Elettrodo-Electrode	010180	10 pcs
(d2)	Elettrodo-Electrode	010182	10 pcs

Accessori - Accessories PAC pag.110

Optional and Consumables

Starter kit	 1x Gouging  3x Ø 0,8 1x 3x  3x Ø 0,9	CR28 Carrello / Trolley	
010084		010889	
WM31 TC True Colour / Grinding DIN 9-13		Guanti (T10) Gloves (S10)	
010408	Filtro auto-oscurante a colori reali 93x43mm True colour auto-darkening filter 93x43mm	010963	
		Grembiule in crosta Crust leather apron (Tg / Size L)	
		010847	

PAC INVERTER 3Ph

NEW!

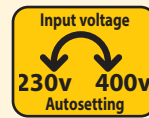

Manutenzione
Maintenance
Carpenteria leggera
Light carpentry
Carpenteria pesante
Heavy carpentry

Taglio al plasma inverter trifase per il taglio manuale ed automatizzato su tutti i materiali ferrosi e non ferrosi purchè conduttivi elettricamente: acciaio rame alluminio acciaio inossidabile, ecc.

- Il display grafico multicolore semplifica il controllo del processo di taglio. Basta selezionare il materiale ed il suo spessore ed è pronto per tagliare.
- i-PAC 370 taglia fino a 25 mm di spessore con una ottima qualità nella superficie. Se non ci sono particolari richieste di qualità la macchina taglia fino a 35mm di spessore.
- Corrente massima di taglio 70A.
- L'arco di taglio è acceso automaticamente per mezzo dell'arco pilota. Questo garantisce una maggiore vita dei consumabili della torcia.
- Il taglio su lamiere perforate e la partenza da pieno sono rese possibili dalla tecnologia che commuta dall'arco pilota all'arco di taglio.
- La funzione Scriccatura è utile per rimuovere i difetti nel cordone di saldatura, pulire sbavature, ecc.
- Alimentazione trifase a 230/400V con selezione automatica.

Three-phase inverter plasma cutter for manual and automated cutting on all ferrous and non-ferrous materials as long as electrically conductive: steel, copper, aluminum, stainless steel, etc.

- The multicolour graphic display makes it easy to control the plasma cutting process. By just selecting the material and plate thickness the machine is ready for cutting.
- i-PAC 370 handles up to 25 mm plates with a quality cut. If there are no special demands about the quality of the cut surface, it can cut plates that are up to 35mm.
- Max cutting current 70A.
- The plasma arc is ignited automatically via the pilot arc. This means longer service life of wear parts in the torch body.
- Cutting in perforated or punched plates is possible due to the advanced technology that makes the machine switch between cutting arc and pilot arc.
- The Gouging function is useful to remove lack of fusion in weld seam or to remove burrs from welded parts.
- 3Ph x 230/400V input voltage with autosetting.



Multilingua / Multilanguage



3 opzioni di funzionamento
Taglio / Grigliato / Scriccatura.
Three options available
Cut / Cut on grid / Gouging.

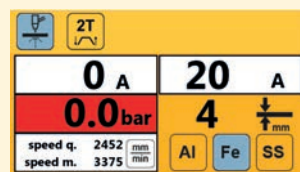

Taglio Sinergico
In base al materiale ed allo spessore l'impianto imposta la corrente di taglio e suggerisce la velocità di avanzamento.
Synergic cutting
According to the workpiece thickness and material, the machine sets the best cutting current and suggest the forward speed.

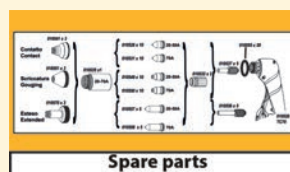

Lista consumabili
Facile identificazione dei consumabili necessari per mantenere la torcia al massimo delle prestazioni.
List of consumables
Easily identification of the consumables needed to keep the torch always at top performance.



Pressostato digitale
Controlla il flusso di aria ed impedisce le operazioni di taglio in caso di anomalie.
Digital air pressure control
It detects air flow and inhibits cutting operation if necessary.

MADE IN SAN MARINO		i-PAC 370 LAB	
Tensione di alimentazione - Input voltage (auto-setting)	3ph 400V ± 15% 50/60Hz	3ph 230V ± 15% 50/60Hz	
Potenza assorbita - Absorbed power: 60% / Max	6,2 / 8,8 kW	4,5 / 6,7kW	
Fusibile - Fuse	16A	16A	
Generatore - Generator	+/- 15% (13kW)	+/- 15% (10kW)	
Rendimento - Efficiency	> 85%	> 85%	
Taglio / Separazione* - Cut / Separation*	25 mm / 35 mm	15 mm / 25 mm	
Corrente di taglio - Cutting current	10 - 70A	10 - 55A	
Servizio 40°C - Duty cycle 40°C EN 60974-1	70A - 30%	55A - 30%	
	50A - 60%	40A - 60%	
	40A - 100%	35A - 100%	
Tensione a vuoto - Open circuit voltage	320V	296V	
Pressione aria min/max - Air pressure min/max	5 - 5,5 bar		
Consumo aria - Air consumption	240 lt/min		
Innesco taglio - Arc striking	Arco pilota - Pilot arc		
Peso - Weight ≈	17,2 kg		
Dimensioni - Dimensions	612 x 232 x 405 mm		
Codice - Code	114900		

Caratteristiche

- Innesco con arco pilota.
- Taglio sinergico o manuale.
- Taglio su grigliato.
- Scricatura.
- Taglio con pantografo.
- Pressostato digitale.
- Cavo della torcia 6m.
- Torcia con sicurezza.
- Facile manutenzione: la lista degli ugelli, elettrodi ed altri consumabili della torcia è sempre disponibile sul display.

Features

- Arc striking with pilot arc.
- Synergic or manual cutting.
- Cut on grid.
- Gouging.
- Cutting with pantograph.
- Digital air pressure control.
- 6m cable torch.
- Safety torch.
- Easy maintenance: the list of nozzles, electrodes and other consumables is always available on the display.

Accessori in dotazione - Supplied accessories

**Consumabili torcia / Torch consumables**

Contatto Contact	010541 3pcs 	010535 - 20/70A 	010528 - 45A 10pcs 	010532 2pcs 	010527 5pcs 	 010520 - TC70
Scricatura Gouging	010551 3pcs 	010535 - 20/70A 	010549 - 45A 10pcs 	010532 2pcs 	010527 5pcs 	
Esteso Extended	010570 3pcs 	010535 - 20/70A 	010557 - 45A 5pcs 	010532 2pcs 	010556 5pcs 	
Automatic	010542 3pcs 	010535 - 20/70A 	010528 - 45A 10pcs 	010532 2pcs 	010527 5pcs 	
		010554 - 20/70A Ohmic 	010531 - 70A 10pcs 			

Accessori - Accessories PAC pag.110

Optional and Consumables

TC70A Torcia plasma automatica CNC plasma torch		Kit connessione a pantografo Kit CNC connection		Starter kit (010527) (010528) (010531)	45A x10 x 5 	70A x10 	CRMI Carrello / Trolley	
6mt 010552		010548		010854			010823	

MMA TRADITIONAL

Manutenzione
Maintenance
Carpenteria leggera
Light carpentry
Cantiere edile
Construction site



- Elettrodi rutili e basici
- Semplici e potenti
- Robuste e durevoli
- Carrozzeria resistente
- Rutile and basic electrodes
- Easy to use and powerfull
- Sturdy and durable
- Tough housing

MADE IN SAN MARINO



	T-ARC 525 LAB	T-ARC 527 LAB	T-ARC 530 LAB	
Tensione di alimentazione - Input voltage	1 ph - 230/400V 50/60 Hz			
Potenza assorbita - Absorbed power: 60% / Max	2,5 / 7,5 kW	2,5 / 7,5 kW	5 / 9,5 kW	
Fusibile - Fuse	25/20A	32/20A	32/25A	
	MMA AC	MMA AC	MMA AC	
Campo di regolazione - Welding current range	40 - 240A	50 - 240A	26 - 280A	22 - 250A
Selezione uscita - Output selection			50V	70V
Servizio 40°C - Duty cycle 40°C EN 60974-1	220A - 8%	220A - 10%	260A - 20%	230A - 20%
	80A - 60%	90A - 60%	155A - 60%	130A - 60%
Tensione a vuoto - Open circuit voltage	44 - 54V	42 - 48V	38 - 77V	
Elettrodi : ø mm	Rutile	1,6 - 5,0	1,6 - 5,0	
Electrodes: ø mm	Basico - Basic (AC)	-	2,5 - 4,0	
Connessioni in uscita - Output connection	DX 25 mmq		DX 50 mmq	
Ventilata - Fan cooled	•	•	•	
Protezione termostatica - Thermostatic Protection	•	•	•	
Peso - Weight ≈	25 kg	28 kg	61 kg	
Dimensioni - Dimensions	710 x 350 x 430 mm	420 x 380 x 750 mm	780 x 490 x 615 mm	
Codice - Code	205300	219000	205500	

Accessori - Accessories MMA pag. 99

Kit saldatura / Welding kit s

DS20 200A (T-ARC 525 LAB)	3+2m 25mm ²	• 25	000217
DS20 200A (T-ARC 527 LAB)	3+2m 25mm ²	• 25	000217
DS35 350A (T-ARC 530 LAB)	3+3m 35mm ²	• 50	000205



MMA TRADITIONAL

Carpenteria leggera
Light carpentry
Cantieri edile
Construction site
Carpenteria pesante
Heavy carpentry

69

MMA TRADITIONAL



P-ARC

- Corrente raddrizzata
- Elettrodi rutili e basici
- Robuste e durevoli
- Rectified current
- Rutile / basic electrodes
- Sturdy and durable

E-ARC 860 LAB

- Controllata a tiristore
- Corrente raddrizzata
- Elettrodi cellulosici
- TIG LIFT
- Elettrodi rutili, basici, alluminio
- Comando a distanza in dotazione
- Thyristor controlled
- Rectified current
- Cellulosic electrodes
- TIG LIFT
- Rutile, basic, aluminum electrodes
- Remote control included

MADE IN SAN MARINO		CE		P-ARC 525 LAB	P-ARC 735 LAB	P-ARC 840 LAB	E-ARC 860 LAB
Tensione di alimentazione - Input voltage		1 ph - 230/400V 50/60 Hz		3 ph - 230/400V 50/60 Hz			
Potenza assorbita - Absorbed power: 60% / Max		2,5 / 7,5 kW		6,5 / 14 kW		9 / 17 kW	
Fusibile - Fuse		25/20A		50/32A		63/40A	
		MMA AC		MMA DC		MMA DC	
Campo di regolazione - Welding current		40 - 240A		25 - 155A		55 - 350A	
		70 - 400A		15 - 500A			
Servizio 40°C Duty cycle 40°C EN 60974-1		220A - 8%		145A - 15%		300A - 35%	
		80A - 60%		70A - 60%		250A - 60%	
Tensione a vuoto - Open circuit voltage		44 - 54V		65 - 77V		71 - 78V	
		70 - 76V		85V			
Elettrodi: ø mm Electrodes: ø mm		Rutile		1,6 - 5,0		2,0 - 7,0	
		Basico Basic		2,5 - 3,2		2,5 - 5,0	
		Cellulosic - Cellulosic Alluminio Aluminum		-		-	
		TIG		-		-	
Conessioni in uscita - Output connection		DX 25 mmq		DX 50 mmq		DX 70 mmq	
Ventilata - Fan cooled		•		•		•	
Protezione termostatica - Thermostatic Protection		•		-		-	
Peso - Weight ≈		32 kg		101 kg		112 kg	
Dimensioni - Dimensions		710 x 350 x 430 mm		890 x 570 x 720 mm		800 x 585 x 760 mm	
Codice - Code		205400		227500		227600	
		220100					

Accessori - Accessories MMA pag. 99

Kit saldatura / Welding kit

DS20 200A (P-ARC 525 LAB)	3+2m 25mm ²	• P 25	000217
DS35 350A (P-ARC 735 LAB)	3+3m 35mm ²	• P 50	000205
DS50 500A (P-ARC 840 LAB)	3+3m 50mm ²	• P 70	000207
DS60 600A (E-ARC 860 LAB)	3+3m 70mm ²	• P 70	000209



Torcia TIG / TIG Torch
TG17 180A - 4m
Dx 50mmq
(1,6 WR2 acciaio-steel)

010785

E-ARC 860



D-mig 5 LAB

MIG / MAG TRADITIONAL

Manutenzione
Maintenance
Carpenteria leggera
Light carpentry
Autoriparazioni
Automotive



Alu
Fe
Brazing

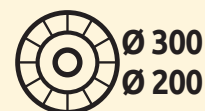
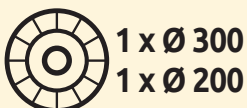

15 kg MAX

La proposta DECA per la carpenteria leggera e carrozzeria. Saldatura MIG/MAG e saldobrasatura MIG per acciaio galvanizzato.

- Il controllo MIG Synergic facilita il lavoro del saldatore gestendo in sinergia con le altre impostazioni della saldatrice, la velocità del filo, la rampa iniziale ed il burn back. Il saldatore deve soltanto attivare uno dei programmi preimpostati.
- Il modello D-mig 532TDKE utilizza contemporaneamente due diversi materiali e gas come: acciaio, alluminio o fili per saldobrasatura. E' predisposto per la torcia Spool-gun.

The DECA proposal for light carpentry and car-body repair. Welding processes: MIG/MAG and MIG brazing process for galvanised steel.

- The Synergic MIG control facilitates the welding machine operator's work as it manages wire speed, soft start and burn back in a synergic way with the rest of the machine settings. The welding machine operator must simply activate one of the pre-set programs.
- The model D-mig 532TDKE uses two different materials and gases simultaneously for example: steel, aluminum or wire for brazing. It is ready for Spool-gun torch

Simple Weld

Synergic Digital Control

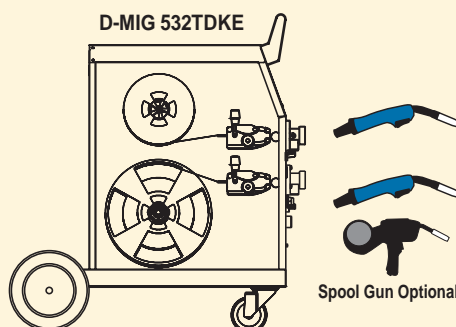
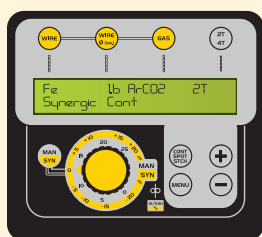

Porta torcia
Torch holder

MADE IN SAN MARINO 		D-mig 525T LAB	D-mig 530SD LAB	D-mig 532TDKE
Tensione di alimentazione - Input voltage		3 ph - 230/400V -	1 ph - 230V - 50/60Hz	3 ph-230/400V- 50/60 Hz
Potenza assorbita - Absorbed power: 60% / Max		3,5 / 5,3 kW	2,4 / 5,5 kW	3,4 / 5 kW
Fusibile - Fuse		16/10A	32A	16/10A
Campo di regolazione - Welding current		20 - 220A	25 - 240A	20 - 220A
Posizioni di saldatura - Welding positions		7	6	10
Servizio 40°C - Duty cycle 40°C EN 60974-1		170A - 45%	200A - 15%	160A - 45%
		140A - 60%	100A - 60%	140A - 60%
Tensione a vuoto - Open circuit voltage		17 - 34V	28 - 62V	16,5 - 32V
Modalità - Mode		MANUAL	SIMPLE WELD MIG MAG SYNERGIC	
Filo ø mm Wires ø mm	Acciaio - Steel	0,6 - 0,8 - 1,0	0,6 - 0,8 - 1,0	0,6 - 0,8 - 1,0
	Inox	0,8 - 1,0	0,8 - 1,0	0,8 - 1,0
	Al.Mg 5 - Al.Si 5	0,8 - 1,0	0,8 - 1,0	0,8 - 1,0
	Cu.Si 3	0,8 - 1,0	0,8 - 1,0	0,8 - 1,0
Bobina Ø mm - Wire spool Ø mm		200 - 300	200 - 300	100 - 200 + 200 - 300
Peso - Weight ≈		52 kg	57 kg	65 kg
Dimensioni - Dimensions		840 x 505 x 765 mm	840 x 505 x 765 mm	845 x 505 x 780 mm
Codice - Code		258800	259100	259500

D-mig 525T, 530SD: accessori in dotazione - Supplied accessories:

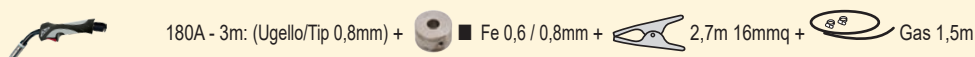

D-mig 532TDKE Accessori in dotazione - Supplied accessories:

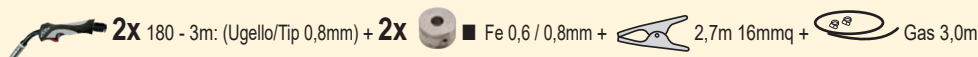

D-mig 525T Features

Funzioni

D-mig 530SD - D-mig 532TDKE

- Funzionamento **SINERGICO** o manuale.
- Regolazione fine della velocità del filo.
- Funzioni pulsante torcia: 2/4T/ Spot/Stitch.
- Soft start, Burn Back.
- Amperometro / Voltmetro.
- Trainafilo a 2 rulli.
- Connessioni: DX25.

Funzioni D-mig 525T

- **Pannello comandi semplificato**
- Saldatura manuale.
- Funzioni pulsante torcia: 2/4T / Spot.
- Trainafilo a 2 rulli ingranati.
- Connessioni: DX25.

D-mig 530SD - D-mig 532TDKE

Features

- **Synergic** or manual welding mode.
- Fine wire speed regulation.
- Torch trigger mode: 2/4T / Spot / Stitch.
- Soft start, Burn Back.
- Ammeter / Voltmeter.
- 2 roll wire feeder.
- Connections: DX25.

D-mig 525T Features

- **Simplified control panel**
- Manual welding.
- Torch trigger mode: 2/4T/ Spot.
- 2 rolls wire feeder.
- Connections: DX25.

Accessori - Accessories MIG / MAG pag.104

Optional and Consumables					
<ul style="list-style-type: none"> ■ (Fe) Acciaio / Steel 0,6 5,0kg 010801 0,8 5,0kg 010805 1,0 5,0kg 010846 ■ (AlMg) Alluminio 1,0 2,0kg 010876 ■ (AlSi) Alluminio 1,0 2,0Kg 010860 ■ (CuSi3) Brazing 0,8 2,0kg 010845 		EP15 Pistol Grip 180 @ 60% 3 m 010507 4 m 010508 DE 230A 230 @ 60% 3m 010584	 	Starter kit Alu 1,0mm Guaina / Torch liner Al 1,0/1,2 (010856) + Ugello /Contact tip Al 1,0 3pc (010257) + Rullino /Wire roller Al 0,8/1,0 (010629)	 
Rullino trainafilo Wire roller ■ Fe 1,0/1,2 010628 ■ Al 0,8/1,0 010629		Regolatore di pressione + adattatore CO2 <-> Ar (IT / USA) Pressure regulator + adapter CO2 <-> Ar (IT / USA) 		WM27 DIN 9-13 Filtro auto-oscurante 93x43mm Auto-darkening filter 93x43mm	
Aspo Spool holder Ø 100 010251					010404

D-mig 6 LAB

MIG / MAG TRADITIONAL 3Ph

Carpenteria pesante
Heavy carpentry
Tubazioni
Pipe line



La proposta DECA per la carpenteria pesante. Solidi generatori tradizionali progettati per sostenere cicli intensivi di lavoro.

- Il controllo MIG Synergic facilita il lavoro del saldatore gestendo in sinergia con le altre impostazioni della saldatrice, la velocità del filo, la rampa iniziale ed il burn back. Il saldatore deve soltanto attivare uno dei programmi preimpostati.
- Robuste ed affidabili.

The DECA proposal for heavy carpentry. Solid traditional generators designed to support intensive work cycles.

- The Synergic MIG control facilitates the welding machine operator's work as it manages wire speed, soft start and burn back in a synergic way with the rest of the machine settings. The welding machine operator must simply activate one of the pre-set programs.
- Sturdy and durable.

Simple Weld

Synergic Digital Control

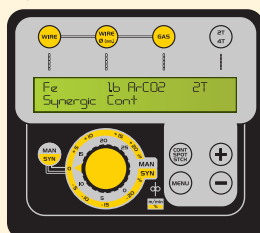

Porta torcia
Torch holder



4 rulli ingranati D.37mm
4 geared rolls D.37mm

MADE IN SAN MARINO 		D-mig 635 T LAB	D-mig 650 T LAB	D-mig 635 TD LAB	D-mig 650 TD LAB
Tensione di alimentazione - Input voltage		3 ph - 230/400V - 50/60 Hz			
Potenza assorbita - Absorbed power: 60% /Max		5,5 / 8,5 kW	10 / 16 kW	5,5 / 8,5 kW	10 / 16 kW
Fusibile - Fuse		25/16A	50/32A	25/16A	50/32A
Modalità - Mode		MANUAL		SIMPLE WELD SYNERGIC	
Campo di regolazione - Welding current		25 - 350A	30 - 500A	25 - 350A	30 - 500A
Posizioni di saldatura - Welding positions		10	21	10	21
Servizio 40°C - Duty cycle 40°C EN 60974-1		270A - 32%	410A - 33%	270A - 32%	410A - 33%
		200A - 60%	310A - 60%	200A - 60%	310A - 60%
Tensione a vuoto - Open circuit voltage		17 - 41V	17 - 49V	17 - 41V	17 - 49V
Modalità - Mode		MANUAL		SYNERGIC - MANUAL	
Filo ø mm Wires ø mm	Acciaio - Steel	0,8 - 1,0 - 1,2 - 1,6		0,8 - 1,0 - 1,2 - 1,6	
	Inox	0,8 - 1,0 - 1,2 - 1,6		0,8 - 1,0 - 1,2 - 1,6	
	Al.Mg 5 - Al.Si 5	1,0 - 1,2 - 1,6		1,0 - 1,2 - 1,6	
	Filo animato - Flux cored	1,2 - 1,6		1,2 - 1,6 (manual)	
Bobina Ø mm - Wire spool Ø mm		200 - 300			
Peso - Weight ≈		95 kg	122 kg	95 kg	122 kg
Dimensioni - Dimensions		870 x 540 x 1020 mm			
Codice - Code		262200	263799	262600	263499

D-mig 635T, 635TD: accessori in dotazione - Supplied accessories:

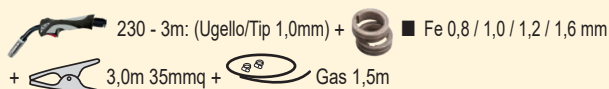

D-mig 650T, 650TD: accessori in dotazione - Supplied accessories:



Funzioni D-mig 635 SD - D-mig 650 TD

- Funzionamento **SINERGICO** o manuale.
- Regolazione fine della velocità del filo.
- Funzioni pulsante torcia: 2/4T/Spot/ Stitch.
- Soft start, Burn Back.
- Amperometro / Voltmetro.
- Trainafile a 4 rulli ingranati.
- Connessioni: DX70.

Funzioni D-mig 635 T - 650 T

- **Pannello comandi semplificato**
- Saldatura manuale.
- Funzioni pulsante torcia: 2/4T / Spot.
- Trainafile a 4 rulli ingranati.
- Connessioni: DX70.

D-mig 635 SD - D-mig 650 TD Features

- **Synergic** or manual welding mode.
- Fine wire speed regulation.
- Torch trigger mode: 2/4T /Spot / Stitch.
- Soft start, Burn Back.
- Ammeter / Voltmeter.
- 4 geared rolls wire feeder.
- Connections: DX70.

D-mig 635T - 650T Features

- **Simplified control panel**
- Manual welding.
- Torch trigger mode: 2/4T/Spot.
- 4 geared rolls wire feeder.
- Connections: DX70.

Accessori - Accessories MIG / MAG pag.104

Optional and Consumables			
■(Fe) Acciaio / Steel 0,6 5,0kg 010801 0,8 5,0kg 010805 1,0 5,0kg 010846 ■(AlMg) Alluminio 1,0 2,0kg 010876 ■(AlSi) Alluminio 1,0 2,0kg 010860 ■(CuSi3) Brazing 0,8 2,0kg 010845		EP25 Pistol Grip 230 @ 60% 3 m 010576 4 m 010577	
Rullino trainafile Wire roller ■Flux 1,2/1,6 011210 ■Al 0,8/1,0 011208 ■Al 1,2/1,6 011209		EP36 Pistol Grip 330 @ 60% 3 m 010578 4 m 010579	
Regolatore di pressione + adattatore CO2 <-> Ar (IT / USA) Pressure regulator + adapter CO2 <-> Ar (IT / USA) ■ ■ ■ 010836		WM27 DIN 9-13 Filtro auto-oscurante 93x43mm Auto-darkening filter 93x43mm 010404	



La proposta DECA per la carpenteria pesante. Solidi generatori tradizionali progettati per sostenere cicli intensivi di lavoro.

- Il controllo MIG Synergic facilita il lavoro del saldatore gestendo in sinergia con le altre impostazioni della saldatrice, la velocità del filo, la rampa iniziale ed il burn back. Il saldatore deve soltanto attivare uno dei programmi preimpostati
- Robuste ed affidabili.

The DECA proposal for heavy carpentry. Solid traditional generators designed to support intensive work cycles.

- The Synergic MIG control facilitates the welding machine operator's work as it manages wire speed, soft start and burn back in a synergic way with the rest of the machine settings. The welding machine operator must simply activate one of the pre-set programs.
- Sturdy and durable.

Simple Weld

Synergic Digital Control

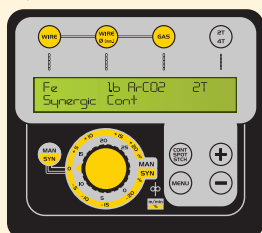



Gruppo raffreddamento (optional)
Water cooling unit (on request)



Porta torcia
Torch holder





4 rulli ingranati D.37mm
4 geared rolls D.37mm

 MADE IN SAN MARINO		D-mig 735 TD LAB	D-mig 750 TD LAB	D-mig 760 TD LAB
Tensione di alimentazione - Input voltage	3 ph - 230/400V - 50/60 Hz			
Potenza assorbita - Absorbed power: 60% /Max	5,5 / 8,5 kW	10 / 16 kW	13 / 20 kW	
Fusibile - Fuse	25/16A	50/32A	63/40A	
Rendimento - Efficiency	< 85%	< 85%	< 85%	
Campo di regolazione - Welding current range	25 - 350A	30 - 500A	40 - 600A	
Posizioni di saldatura - Welding positions	10	21	30	
Servizio 40°C - Duty cycle 40°C EN 60974-1	270A - 32%	410A - 33%	470A - 35%	
	200A - 60%	310A - 60%	360A - 60%	
Tensione a vuoto - Open circuit voltage	17 - 41V	17 - 49V	18 - 51V	
Peso - Weight ≈	84 kg	110 kg	125 kg	
Dimensioni - Dimensions	920 x 540 x 940 mm			
Codice - Code	266600	267800	268400	

Trainafile - Wire Feeder		WF 4D LAB	WF4 LAB
Modalità - Mode		SYNERGIC	MANUAL
Filo ø mm Wires ø mm	Acciaio - Steel	0,8 - 1,0 - 1,2 - 1,6	
	Inox	0,8 - 1,0 - 1,2 - 1,6	
	Al.Mg 5 - Al.Si 5	1,0 - 1,2 - 1,6	
	Filo animato - Flux cored	1,2 - 1,6 (manual)	
Bobina Ø mm - Wire spool Ø mm		200 - 300	
Peso - Weight ≈		21,5 kg	13 kg
Dimensioni - Dimensions		640 x 300 x 520 mm	550 x 260 x 480 mm
		269200	269000

					
D-MIG735 266600			WF4D 269200	WF 4 269000	-
	D-MIG750 267800	D-MIG760 268400	WF 4D 269200	WF 4 269000	-
D-MIG735 266600	D-MIG750 267800	D-MIG760 268400	WF4D 269200	WF 4 269000	WU 16 H2O 010666

	
3m AIR 4m AIR 9m AIR	010105 010107 010109
EP 25 - 3m 230A@60 EP 25 - 4m 230A@60	010576 010577
3m AIR 4m AIR 9m AIR	010105 010107 010109
EP 36 - 3m 330A@60 EP 36 - 4m 330A@60	010578 010579
3m H2O 4m H2O 9m H2O	010106 010108 010110
EP 500A H2O - 3m 500A EP 500A H2O - 4m 500A	010580 010581



Accessori in dotazione - Supplied accessories:

WF 4, WF4D  ■ Fe 0,8 / 1,0 / 1,2 / 1,6 mm

D-MIG 735  3,0m 35mmq

D-MIG 750, 760  3,0m 50mmq

Accessori - Accessories MIG / MAG pag.104

Optional and Consumables	
Rullino trainafile Wire roller  <ul style="list-style-type: none"> ■ Flux 1,2/1,6 011210 ■ Al 0,8/1,0 011208 ■ Al 1,2/1,6 011209 	Regolatore di pressione + adattatore CO2 ⇔ Ar (IT / USA) Pressure regulator + adapter CO2 ⇔ Ar (IT / USA)  <ul style="list-style-type: none"> ■ ■ ■ 010836
Kit ruote per WF4 Wheels kit for WF4  <p>010067</p>	

Funzioni con trainafile WF4D

- **Funzionamento SINERGICO** o manuale.
- Regolazione fine della velocità del filo.
- Funzioni pulsante torcia: 2/4T / Spot / Stitch.
- Soft start, Bunn Back.
- Amperometro / Voltmetro.
- Trainafile a 4 rulli ingranati.
- Connessioni: DX70.

Funzioni con trainafile WF4

- Saldatura manuale.
- Funzioni pulsante torcia: 2/4T / Spot.
- Trainafile a 4 rulli ingranati.
- Connessioni: DX70.

Features with WF4D feeder

- **Synergic** or manual welding mode.
- Fine wire speed regulation.
- Torch trigger mode: 2/4T / Spot / Stitch.
- Soft start, Burn Back.
- Ammeter / Voltmeter.
- 4 geared rolls wire feeder.
- Connections: DX70.

Features with WF4

- Manual welding.
- Torch trigger mode: 2/4T / Spot.
- 4 geared rolls wire feeder.
- Connections: DX70.

PAC TRADITIONAL 3Ph



Manutenzione
Maintenance

Carpenteria leggera
Light carpentry

Carpenteria pesante
Heavy carpentry



MADE IN SAN MARINO



	D-PAC 90 LAB	D-PAC 120 LAB
Tensione di alimentazione - Input voltage	3 ph - 230/400V - 50/60 Hz	
Potenza assorbita - Absorbed power: Min / Max	4,5 / 9,5 kW	5,2 / 17 kW
Fusibile - Fuse	25A	50A
Corrente di taglio - Cutting current	40-80A	45-120A
Servizio 40°C - Duty cycle 40°C EN 60974-1	75A - 30%	115A - 30%
	40A - 100%	45A - 100%
Tensione a vuoto - Open circuit voltage	265V	267V
Taglio / Separazione - Cut / Separation	15 / 20 mm	24 / 30 mm
Pressione aria min/max - Air pressure min/max	5 - 6 bar	5 - 6 bar
Innesco con alta frequenza - HF arc striking	•	•
Consumo aria - Air consumption	155 lt/min	210 lt/min
Connettore torcia - Torch connection	Diretto - Direct	Centralizzata - Central connector
Connettore massa - Earth connection	Diretto - Direct	Diretto - Direct
Peso - Weight	77 kg	89 kg
Dimensioni - Dimensions	670 x 615 x 865 mm	670 x 615 x 865 mm
Codice - Code	117900	119300

Taglio plasma trifase con arco stabile ed ottima capacità di taglio.

D-PAC è la gamma per il fabbro e la carpenteria media o pesante.

- Taglio su grigliato.
- Innesco ad alta frequenza

Three-phase plasma cutter with stable cutting arc and excellent cutting capacity.

D-PAC is the range for smiths and medium or heavy carpentry.

- Cut on grid
- High frequency start.

D-PAC 90: Accessori in dotazione - Supplied accessories:

80A - 6 m; 2x Ø 1,2; 1x Ø 1,0 16 mm² - 3,0m Innesco aria - Air connection 8 / 10 mm

D-PAC 120: Accessori in dotazione - Supplied accessories:

100A - 6 m; 1x Ø 1,1; 1x Ø 1,4; 1x Ø 1,7 16 mm² - 3,0m Innesco aria - Air connection 8 / 10 mm

Accessori - Accessories PAC pag.110

CAR BODY REPAIR



SPOT



**DENT
PULLER**

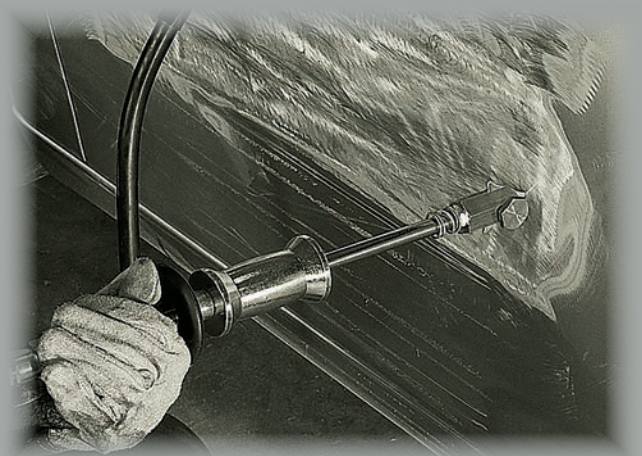

STUD ALU



SW 100 LAB

SPOT WELDER - DENT PULLER



Autoriparazioni
Automotive
Carpenteria leggera
Light carpentry

8000A

SYNERGIC

PULSE
GALVANISED STEEL

SureSpot
Automatic
Compensation



Impianto per la puntatura di lamiera in acciaio per carrozzeria auto. Estremamente potente e semplice da usare.

- Grazie al controllo elettronico la programmazione è molto semplice. In modalità SINERGICA l'utilizzatore deve indicare solo lo spessore del metallo. In modalità MANUALE è necessario indicare il tempo e la corrente di saldatura.
- La pinza puntatrice pneumatica e la pistola studder sono sempre pronte all'uso.
- Con la pistola studder si può eseguire la puntatura da un solo lato, la saldatura di rivetti, rondelle e l'uso del martello tirabolle ed del carbone caldaliere.
- Il carrello ed il braccio di supporto per gli attrezzi rende molto comodo il suo utilizzo.

Spot welding system for car steel bodywork. Extremely powerful and easy to use.

- Thanks to the electronic control the unit can be programmed easily. In SYNERGIC mode the user needs only to select steel thickness. In MANUAL mode, user sets welding time and welding current.
- The pneumatic gun and studder gun are always ready for use at the same time.
- With studder gun it is possible perform: single-sided spot welding, hammer welding, rivet, washer welding, carbon shrinking.
- Trolley and tool support arm make it very convenient to use.

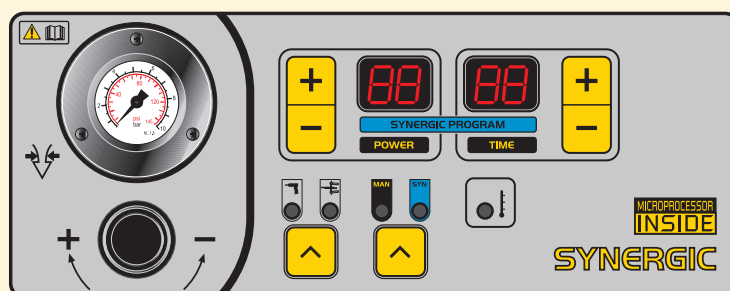

 MADE IN SAN MARINO		SW 100 LAB
Tensione di alimentazione - Input voltage	1 ph - 400V 50/60 Hz	
Potenza installazione - Installation power 50% /100%	11,2 kW - 47,0 kW	
Fusibile - Fuse	32A (D)	
Campo di regolazione - Welding current (I RMS)	200-8000A	
Tensione a vuoto - Open circuit voltage	0,8 - 10,1V in 99 steps	
Capacità di saldatura - Welding capacity	3 + 3 mm	
Punti/ora - Spots/hour 0,8 + 0,8 mm	600	
Punti/ora - Spots/Hour 3 + 3 mm	75	
Metalli saldabili - Weldable Metals	Acciaio - Steel	
	Inox	
	Zincato - Galvanized	
	AHSS	
Riduttore di pressione - Pressure reducer	•	
Trasformatore in rame - Copper Transformer	•	
Protezione termostatica - Thermostatic Protection	•	
Peso - Weight ≈	85 kg	
Dimensioni - Dimensions	725 x 650 x 1060 mm	
Codice - Code	276600	

*Accessori in dotazione - Supplied accessories:

Carrello con braccio porta utensili, pistola puntatrice pneumatica, pistola studder, cavo di massa, kit accessori studder

Trolley with arm, pneumatic spot gun, studder gun, earth cable, studder gun accessory kit

Funzioni Puntatrice

- Funzionamento **SINERGICO** Regola automaticamente i parametri di saldatura in base all'utensile selezionato ed allo spessore da saldare. E' possibile personalizzare il tempo e della corrente di lavoro.
- Tabella parametri di saldatura.
- Funzione **PULSE**: Puntatura a punto singolo e punto singolo pulsato per lamiere ad alto limite di snervamento e lamiere zincate.
- Funzione **SURE-SPOT**: La compensazione automatica assicura l'uniformità di tutti i punti di saldatura.
- Pistola studder per puntatura da un solo lato e per la riparazione di ammaccature ed il raddrizzamento degli elementi della carrozzeria con uno spessore sottile.

Predisposizioni:

- Gruppo di raffreddamento per bracci puntatrice.

Features

- **SYNERGIC** function. It automatically sets the welding parameters according to the selected tool and the workpiece thickness. It is possible to adjust time and spot welding current.
- Welding parameters chart.
- **PULSE** function. Continuous single spot and pulse single spot for sheet metals high yield strength and galvanized steel.
- **SURE-SPOT** function. Automatic compensation grants all welding spot evenness.
- Studder gun for single-side spot welding and for dent pulling and straightening of low thickness car body elements.

Arranged for:

- Water cooling unit for pneumatic spot gun arms.



Accessori - Accessories DENT PULLER pag.88 - SPOT pag.94

Kit Bracci - Kit Arms WATER Cooled pag. 94

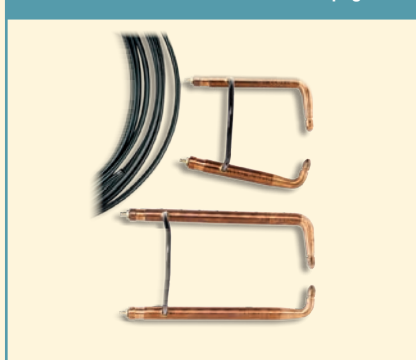

Unità raffreddamento - Water cooling unit pag. 94



Kit Bracci - Kit Arms AIR Cooled pag. 94

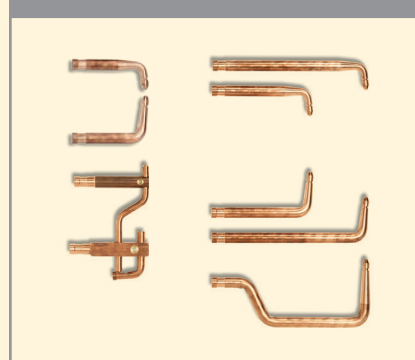

SW 18 - SW 28 LAB

LAB

DENT PULLER

3200A

4500A

Autoriparazioni
Automotive

ACCIAIO
STEEL

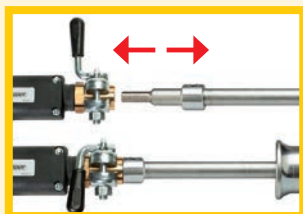

SW 18 / 28 con rispettivamente una potenza di 3200 e 4500A sono l'ideale per la riparazione di ammaccature e la raddrizzatura di lamiere sottili (cofani, portiere, cieli ecc.). Offrono differenti funzioni per tanti utilizzi della carrozzeria.

- Il basso consumo di energia gli consente di funzionare con una alimentazione a 230V.
- Facile da usare: la regolazione del tempo e della potenza è indicata in una tabella di aiuto.

SW 18 / 28 with a maximum output of 3200 and 4500A respectively are the ideal products for dent pulling and straightening out low thickness components (bonnets, doors and roof panels etc.) They offer different functions for many uses on carbody repair.

- With their low power consumption, they operate effectively on a 230V power supply.
- Easy to use: time and power settings are indicated in a help table.



MADE IN SAN MARINO	CE	SW 18 LAB	SW 28 LAB
Tensione di alimentazione - Input voltage		1 ph - 220/240V 50/60 Hz	1 ph - 230V 50/60 Hz
Potenza assorbita - Absorbed power: 50% / Max		1,5 / 3 kW	2,7 / 4 kW
Fusibile - Fuse		16A	16A
Campo di regolazione - Welding current (I2 MAX)		3200A	4500A
Campo di regolazione - Welding current (I RMS)		1600A	400-2800A
Tensione a vuoto - Open circuit voltage		5,8V	2,4 - 7,4V in 50 steps
Metalli saldabili - Weldable Metals		Acciaio - Steel	
		Inox	
		Zincato - Galvanized	
Trasformatore in Rame - Copper Transformer		-	•
Protezione termostatica - Thermostatic Protection		•	•
Cavo pistola studder - Gun cable		2,0m 50 mmq	2,4m 70 mmq
Cavo massa - Earth cable		1,6m 50 mmq	1,6m 70 mmq
Peso - Weight ≈		16,6 kg	20 kg
Dimensioni - Dimensions		315 x 186 x 258 mm	315 x 186 x 258 mm
Codice - Code		273000	270600

*Accessori in dotazione - Supplied accessories:



Funzioni

- Pistola con grilletto: il punto di saldatura è comandato attraverso il grilletto.
- Regolazione del tempo a di saldatura (SW18)
- Regolazione del tempo e della potenza di saldatura (SW28)
- Tabella parametri di saldatura
- Saldatura a punto singolo
- Saldatura a punto singolo pulsato (SW28)
- Saldatura in continua (SW28)
- Elettrodo scaldalamiere
- Attacco rapido per cambio utensili
- Massa a puntare

Features

- Gun with trigger: the welding point is controlled through the trigger.
- Welding time setting (SW18)
- Welding time and power setting (SW28)
- Welding parameters chart
- Single spot welding
- Pulse single spot welding (SW28)
- Continuous spot welding (SW28)
- Carbon heating electrode
- Quick link for fast tool changing
- Pointing mass

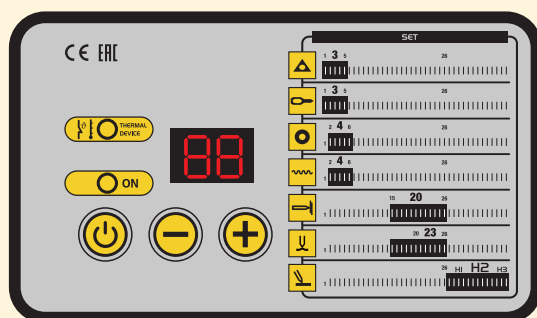

SW 18 LAB

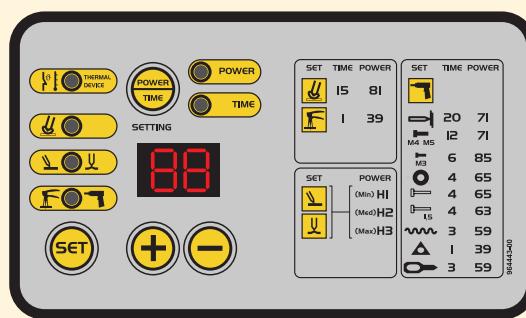

SW 28 LAB

Accessori - Accessories DENT PULLER pag. 88

KST1 Kit Tiro - Puller Kit 010093

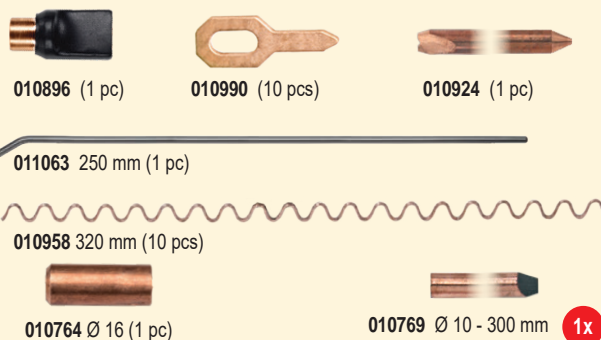

KST3 Kit Tiro rondelle - Puller Kit washers 010095

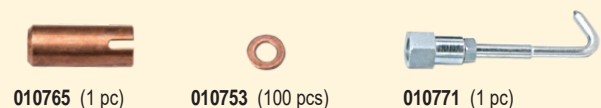

KST5 Kit Tiro perni - Puller Kit rivets 010092



KST2 Kit Tiro consumabili - Puller Kit consumables 010094

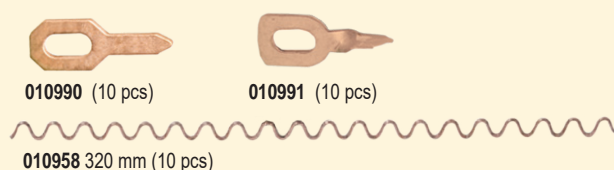

4500A

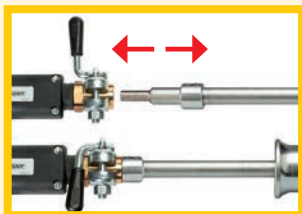

SW 58 con una potenza di 4500A è l'ideale per la riparazione di ammaccature e la raddrizzatura di lamiere sottili (cofani, portiere, cieli ecc.). Offre differenti funzioni per tanti utilizzi della carrozzeria.

- Il basso consumo di energia gli consente di funzionare con una alimentazione a 230V.
- Facile da usare: la regolazione del tempo e della potenza è indicata in una tabella di aiuto.
- Massima comodità di lavoro con due pistole con differenti regolazioni: pistola con innesco a contatto e pistola con grilletto.

SW 58 with a maximum output of 4500A is the ideal product for dent pulling and straightening out low-thickness components (bonnets, doors and roof panels etc.) It offers different functions for many uses on carbody repair.

- With a low power consumption, it operates effectively on a 230V power supply.
- Easy to use: time and power settings are indicated in a help table.
- Maximum working comfort with two guns with different settings: contact gun and gun with trigger.



 MADE IN SAN MARINO	CE	SW 58 LAB
Tensione di alimentazione - Input voltage	1 ph - 230V 50/60 Hz	
Potenza assorbita - Absorbed power 50% / Max	2,7 / 4 kW	
Fusibile - Fuse	16A	
Campo di regolazione - Welding current (I2 MAX)	4500A	
Campo di regolazione - Welding current (I1 RMS)	400-2800A	
Tensione a vuoto - Open circuit voltage	2,4 - 7,4V in 50 steps	
Metalli saldabili - Weldable Metals	Acciaio - Steel	
	Inox	
	Zincato - Galvanized	
Trasformatore in Rame - Copper Transformer	•	
Protezione termostatica - Thermostatic Protection	•	
Cavo pistola a contatto - Contact-gun cable	3,0m 50 mmq	
Cavo pistola a grilletto -Trigger-gun cable	2,4m 70 mmq	
Cavo massa - Earth cable	1,6m 70 mmq	
Peso - Weight =	21 kg	
Dimensioni - Dimensions	340 x 218 x 258 mm	
Codice - Code	274100	

*Accessori in dotazione - Supplied accessories:



010093 KST1 Kit Tiro - Puller Kit

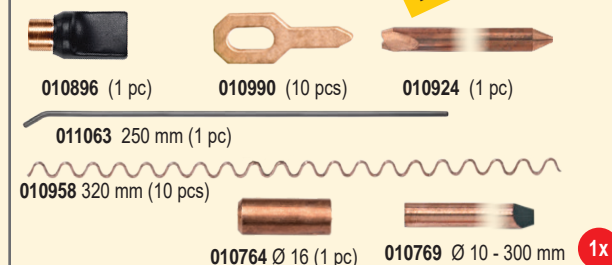

Funzioni

- Pistola con innesco a contatto: il punto di saldatura si genera appena l'utensile è a contatto con il pezzo da raddrizzare
- Pistola con grilletto: il punto di saldatura è comandato attraverso il grilletto.
- Regolazione del tempo e della potenza di saldatura
- Tabella parametri di saldatura
- Saldatura a punto singolo
- Saldatura a punto singolo pulsato
- Saldatura in continua
- Elettrodo scaldalamiere
- Attacco rapido per gli utensili
- Massa a puntare

Features

- Contact gun: the welding point is generated as soon as the tool is in contact with the piece to be straightened
- Gun with trigger: the welding point is controlled through the trigger.
- Welding time and power setting
- Welding parameters chart
- Single spot welding
- Pulse single spot welding
- Continuous spot welding
- Carbon heating electrode
- Quick link for fast tool changing
- Pointing mass

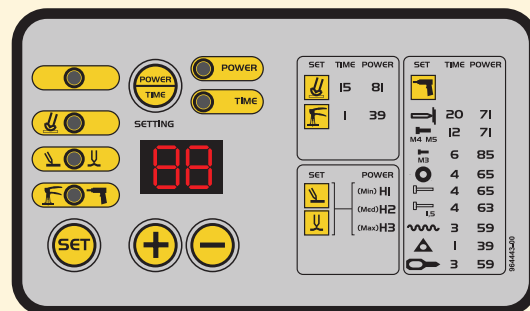

Accessori - Accessories DENT PULLER pag. 88

KST5 Kit Tiro perni - Puller Kit rivets 010092

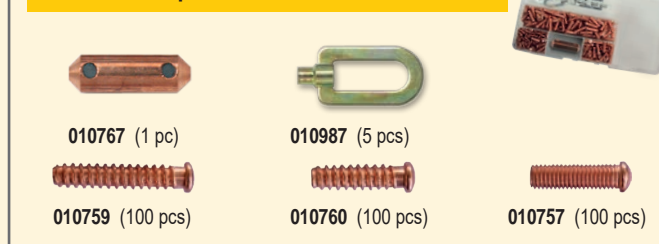

KST2 Kit Tiro consumabili - Puller Kit consumables 010094

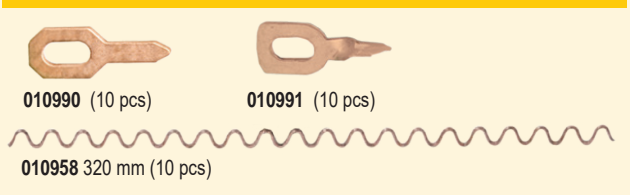

KST3 Kit Tiro rondelle - Puller Kit washers 010095

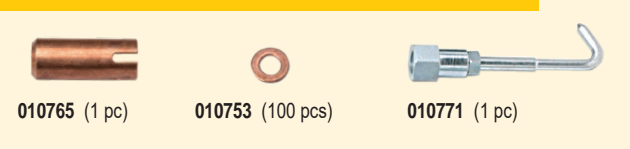

Pull-ARC 250 LAB

DRAWN ARC INVERTER

Autoriparazioni
Automotive
Carpenteria leggera
Light carpentry

ALLUMINIO
ALUMINUM
ACCIAIO
STEEL



Saldatrice monofase a tecnologia DRAWN ARC appositamente studiata per la riparazione di ammaccature e raddrizzamento di lamiere sottili specialmente di alluminio ed acciaio.



- Facile e veloce da usare non richiede gas.
- Differenti funzioni per tanti utilizzi della carrozzeria
- Pannello di controllo grafico a colori.
- Pacchetto programmi standard di oltre 40 programmi per Alluminio ed acciaio.
- Memoria digitale per salvare le impostazioni di saldatura preferite ed SD-Card per aggiornare ed aggiungere programmi



Single-phase welding machine with DRAWN ARC technology specifically designed for repairing of dents and straightening of thin metal sheets especially aluminum and steel.

- Quick and easy to use, it does not require gas.
- Different functions for many uses on carbody repair
- Multicolor graphic display.
- Standard package of 40+ welding programs for both aluminum and steel is included.
- Digital memory: to save one's favorite welding settings and SD-Card to update and add programs.



 MADE IN SAN MARINO		Pull-ARC 250 LAB
Tensione di alimentazione - Input voltage	1 ph - 230V 50/60 Hz	
Potenza assorbita - Power absorption: Max	300W	
Fusibile - Fuse	16A	
Rendimento - Efficiency	90%	
Campo di regolazione - Welding current (I RMS)	50-200A	
Tensione a vuoto - Open circuit voltage	75V	
Metalli saldabili - Weldable Metals	AlMgSi - AlMgSi	
	Acciaio - Steel	
	Inox - Stainless steel	
	Zincato - Galvanized steel	
Cavo pistola - Trigger-gun cable	2,5m	
Peso - Weight ≈	5,5 kg	
Dimensioni - Dimensions	370 x 160 x 274 mm	
Versione - Version		
*Generatore + accessori *Power source + accessories	272700	
Pull ARC Basic Kit	272791	

*Accessori in dotazione - Supplied accessories:

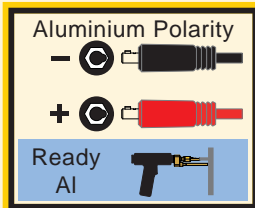
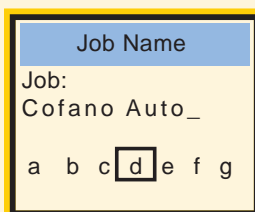
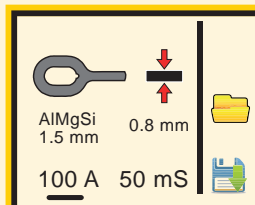
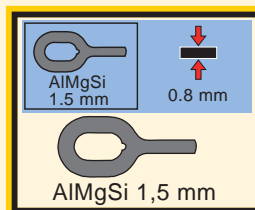
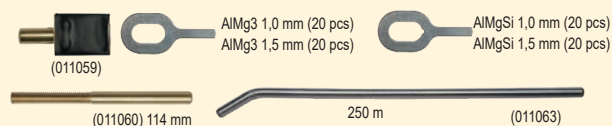

Funzioni

- **Funzione automatica.** La corrente e il tempo di saldatura si regolano in modo sinergico in base al particolare da saldare ed allo spessore di lavoro.
- **Funzione manuale.** E' possibile regolare in modo fine la corrente e il tempo di saldatura partendo dal programma precedentemente scelto.
- **Salvataggio programmi.** Consente di ritrovare facilmente i parametri ottimali per le applicazioni ricorrenti.
- **Indicazione polarità.** Indica la corretta polarità per la pistola in base al materiale di lavoro.

Features

- **Automatic setting.** Welding current and time are set in synergic mode according to the specific piece to be welded and the material thickness.
- **Manual operation.** It is possible to fine-tune current and welding time starting from the previously selected program.
- **Saving programs.** It allows to easily find the optimal parameters for recurring applications.
- **Polarity setting.** It informs about the correct polarity connection of the gun according to the material.

Accessori - Accessories DRAWN ARC pag. 90

Pull ARC 250 Basic Kit 272791

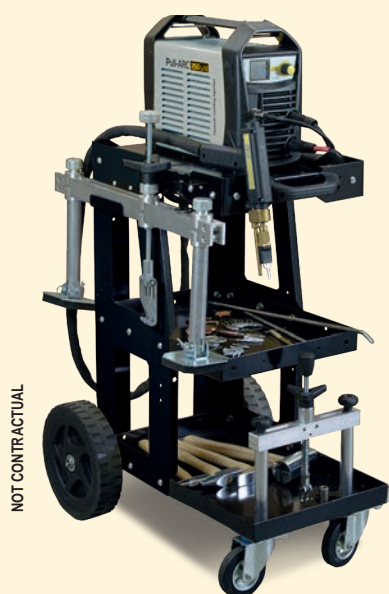

NOT CONTRACTUAL



272700
Pull Arc 250 LAB

010889
Carrello CR28
CR28 Trolley

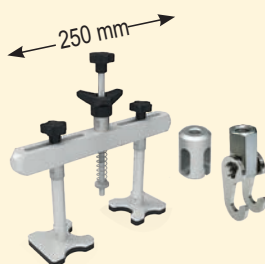

011044 250 mm (1 pc)



011046 AlMg3 1,5 mm (50 pcs)



011047 AlMg3 1,5 mm (50 pcs)



011050 AlMgSi 1,5 mm (50 pcs)



011051 AlMgSi 1,5 mm (50 pcs)



010966 ø 4 (1 pc)



011054 AlMg3 ø 4 (50 pcs)

STUD WELDER INVERTER



Autoriparazioni
Automotive
Carpenteria leggera
Light carpentry

ALLUMINIO
ALUMINUM

ACCIAIO
STEEL



Saldatrice per perni filettati a scarica capacitiva. Adatta per il settore carrozzeria e la carpenteria leggera.

- In carrozzeria la saldatrice permette di eliminare le ammaccature e gli urti (pannelli della porta, cofano, ecc.) su lamiere sottili di acciaio e alluminio
- Utilizzabile per differenti tipologie di perni, prigionieri filettati su metalli conduttivi come acciaio, inox, zincato, alluminio, rame.
- Display digitale per la visualizzazione della potenza impostata.
- Doppia pinza di massa per massima efficacia di saldatura.

Capacitor discharge stud welder. Ideal for car-body workshops and light carpentry

- In car-body workshops the welder allows to eliminate the dents and bumps (door panels, bonnets, etc.) on steel and aluminum car body.
- Suitable for different thread rivet and threaded stud diameters on conductive metals like: steel, stainless steel, galvanized steel, aluminum, copper.
- Digital display for power settings.
- Double earth clamp for best welding performance.

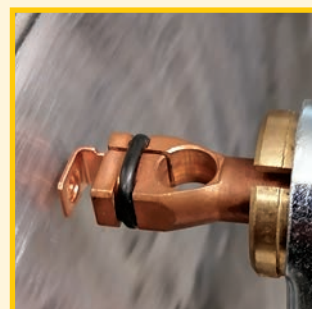
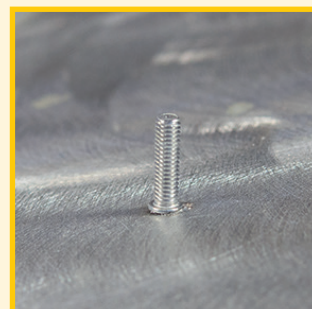
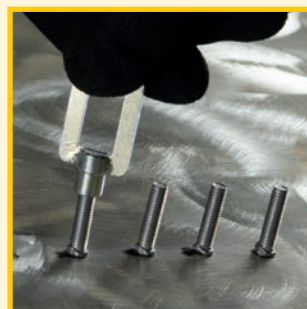



DENT PULLER



SW 18 / 28 / 58 / 100 LAB

Elettrodi - Electrodes / Consumabili - Consumables

010896 Elettrodo per rondelle asolate Electrode for oval washers	(1 pc)	Ø 16		
010990 Rondella asolata Oval washers	(10 pcs)			
010991 Rondella asolata piegata Folded oval washers	(10 pcs)			
010924 Elettrodo spot/filo ondulato Spot/crimped wire electrode	(1 pc)	Ø 10		
010958 320 mm Filo ondulato Crimped welding wire	(10 pcs)			
010772 Rondelle a 3 punte 2 mm 3 Tips washers 2 mm	(20 pcs)			
010765 ø8x16mm Elettrodo per rondelle Electrode for washers	(1 pc)	Ø 16		
010753 ø8x16x1,5 Rondelle Washers	(100 pcs)			
010771 ø8x16mm Mandrino rondelle Mandrin washers	(1 pc)	M14		
010767 M5 - M6 Elettrodo per viti M5-M6 Electrode for M5-M6 screws	(1 pc)	Ø 16 Ø 5 Ø 6		
010760 ø5x18mm Perno autofilettante Self-thread rivets	(100 pcs)	Ø 5		
010759 ø5x25mm Perno autofilettante Self-thread rivets	(100 pcs)	Ø 5		
010757 M5x18mm Perno filettato Thread rivets	(100 pcs)	M5		
010987 Anello di tiro Thread washers	(5 pcs)	M5		
010769 Elettrodo carbone caldalmiere Sheet electrodes	(5 pcs)	Ø 10 300 mm		

010093 KST1 Kit Tiro - Puller Kit

010896 (1 pc)	010990 (10 pcs)	010924 (1 pc)
011063 250 mm (1 pc)		
010958 320 mm (10 pcs)		
010764 Ø 16 (1 pc)	010769 Ø 10 - 300 mm 1x	

010094 KST2 Kit Tiro consumabili - Puller Kit consumables

010990 (10 pcs)	010991 (10 pcs)
010958 320 mm (10 pcs)	

010095 KST3 Kit Tiro rondelle - Puller Kit washers

010765 (1 pc)	010753 (100 pcs)	010771 (1 pc)
----------------------	-------------------------	----------------------

010092 KST5 Kit Tiro perni - Puller Kit rivets

010767 (1 pc)	010987 (5 pcs)	
010759 (100 pcs)	010760 (100 pcs)	010757 (100 pcs)

010923 (1 pc) Supporto magnetico filo ondulato Magnetic support for crimped wire		
---	--	--

010764 (1 pc) Elettrodo per schiacciature Squashing electrode	Ø 16	
--	------	--

010773 (1 pc) Mandrino rondelle a 3 punte Mandrin 3 tips washers	M14		
---	-----	--	--



SW 18 / 28 / 58 / 100 LAB

010091 KST6 Kit Massa piastrino - Earth plate kit

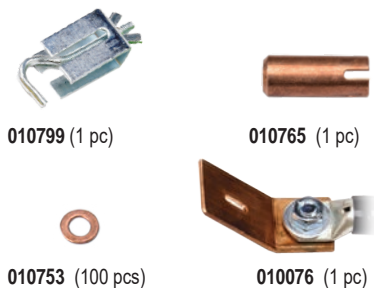

010799 (1 pc)

010765 (1 pc)

010753 (100 pcs)

010076 (1 pc)

Massa - Mass

010799 (1 pc)

Ferma massa
Mass clamp



010076 (1 pc)

Piastrino di massa
Mass clamp



010917 (1 pc)

Massa a puntare
Mass clamp



Martelli - Hammers

010750 Kg 1 (1 pc)

Ø 10/16



M14

010738 Kg 1 (1 pc)

Ø 10/16



M14



010889
Carrello CR28
CR28 Trolley

Leve a tirare - Multihook level

010200 850 mm (1 pc)

KPSH1 KIT Traversa
KPSH1 KIT Levelling bar

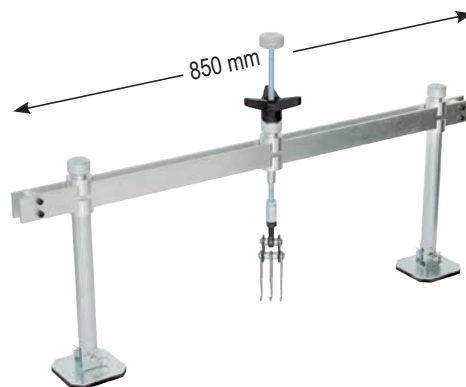

010312 700 mm (1 pc)

KPSL1 Leva a tirare
KPSL1 Multihook lever



011044 250 mm (1 pc)

Traversa
Levelling bar



011063 250 mm (1 pc)

011064 500 mm (1 pc)

Perno di tiro
Traction rod

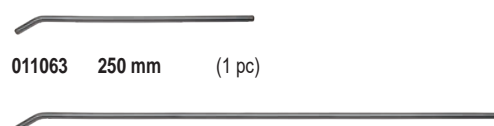





Pull-ARC 250 LAB

Elettrodi - Electrodes / Consumabili - Consumables

Alluminio - Aluminum

Consumabili - Consumables

011048 AIMg3 1,0 mm (50 pcs) 

011046 AIMg3 1,5 mm (50 pcs) 

011049 AIMg3 1,0 mm (50 pcs) 

011047 AIMg3 1,5 mm (50 pcs) 

011052 AIMgSi 1,0 mm (50 pcs) 

011050 AIMgSi 1,5 mm (50 pcs) 

011053 AIMgSi 1,0 mm (50 pcs) 

011051 AIMgSi 1,5 mm (50 pcs) 

011054 AIMg3 ø 4 (50 pcs)

Perno di tiro
Traction nail

Pinza
Clamp

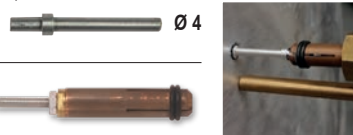

010967 ø 5 (1 pc)

Pinza
Clamp

011061 90 mm (1 pc)

Puntale di massa pistola
Gun earth rod

010059 AIMg3 M4x16 (100 pcs)

Perno filettato
Thread rivets

010974 AISi M5x20 (100 pcs)

Perno filettato
Thread rivets

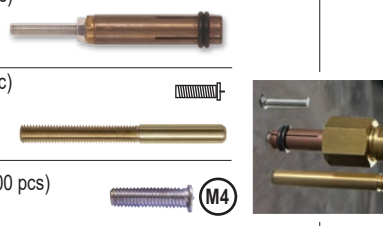

011055 KDA1 Kit rondelle asolate AIMg3 Pulling rings kit AIMg3



011048 AIMg3 1,0 mm (50 pcs)
011046 AIMg3 1,5 mm (50 pcs)

011049 AIMg3 1,0 mm (50 pcs)
011047 AIMg3 1,5 mm (50 pcs)

011056 KDA2 Kit rondelle asolate AIMgSi Pulling rings kit AIMgSi



011052 AIMgSi 1,0 mm (50 pcs)
011050 AIMgSi 1,5 mm (50 pcs)

011053 AIMgSi 1,0 mm (50 pcs)
011051 AIMgSi 1,5 mm (50 pcs)

010081 KDA3 Kit perno di tiro - Traction rod kit

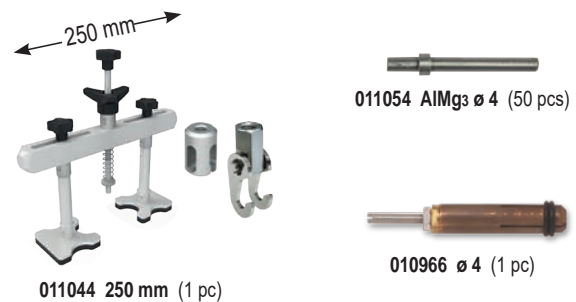

Acciaio - Steel

Consumabili - Consumables

010990 (10 pcs)

Rondella asolata
Oval washers



010991 (10 pcs)

Rondella asolata piegata
Folded oval washers



010757 M5x18 (100 pcs)

Perno filettato
Thread rivets



010759 ø 5x25 (100 pcs)

Perno autofilettante
Self-thread rivets



010760 ø 5x18 (100 pcs)

Perno autofilettante
Self-thread rivets



011059 (1 pc)

Elettrodo per rondelle asolate
Electrode for oval washers

011060 114 mm (1 pc)

Puntale di massa pistola
Gun earth rod

010986 (M4) (5 pcs)

010987 (M5) (5 pcs)

Anello di tiro
Thread washers

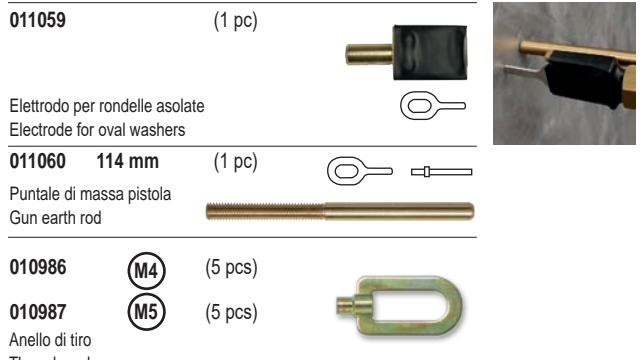



Pull-ARC 250 LAB



011045
Set martelli alluminio
Aluminum hammers kit

Leve a tirare - Multihook lever

010200 850 mm
KPSH1 KIT Traversa
KPSH1 KIT Levelling bar



010312 700 mm
KPSL1 Leva a tirare
KPSL1 Multihook lever

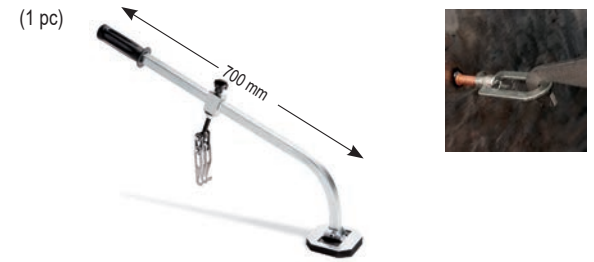

011044 250 mm
Traversa
Levelling bar

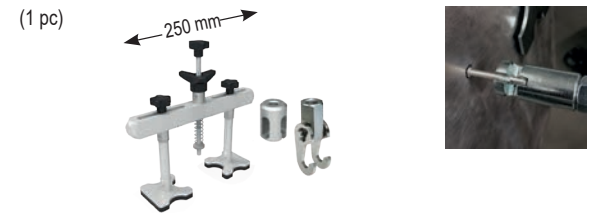

011063 250 mm



011064 500 mm



Perno di tiro
Traction rod

272791 Pull ARC 250 Basic Kit

NOT CONTRACTUAL



272700
Pull Arc 250 LAB

010889
Carrello CR28
CR28 Trolley



011044 250 mm (1 pc)



011046 AIMg3 1,5 mm (50 pcs)



011047 AIMg3 1,5 mm (50 pcs)



011050 AIMgSi 1,5 mm (50 pcs)



011051 AIMgSi 1,5 mm (50 pcs)



010966 ø 4 (1 pc)



011054 AIMg3 ø 4 (50 pcs)



STUD WELDER



STUD SW 15 Alu LAB

Pinze - Clamps

010965	ø 3	(1 pc)	
Pinza Clamp			
010966	ø 4	(1 pc)	
Pinza Clamp			
010967	ø 5	(1 pc)	
Pinza Clamp			
010968	ø 6	(1 pc)	
Pinza Clamp			
010970	ø 6,3	(1 pc)	
Pinza Faston Clamp Faston			

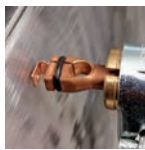

010939 Kit Alu



010965 ø 3 (1 pc)	010966 ø 4 (1 pc)
010967 ø 5 (1 pc)	010970 ø 6,3 (1 pc)
010979 6,3x0,8 (100 pcs)	010059 M4x16 (100 pcs)
010974 M5x20 (100 pcs)	010986 M4 (5 pcs)
	010987 M5 (5 pcs)

Alluminio - Aluminum

Consumabili - Consumables

010979 AIMg3 M6,3x0,8 (100 pcs)	
Faston	
010059 AIMg3 M4x16 (100 pcs)	(M4)
Perno filettato Thread rivets	
010974 AISi M5x20 (100 pcs)	(M5)
Perno filettato Thread rivets	

Acciaio - Steel

Consumabili - Consumables

010983 6,3x0,8 (100 pcs)	
Faston	
010980 M4x12 (100 pcs)	(M4)
Perno filettato Thread rivets	
010989 M5x16 (100 pcs)	(M5)
Perno filettato Thread rivets	
010975 M6x20 (100 pcs)	(M6)
Perno filettato Thread rivets	

010940 Kit Fe



010966 ø 4 (1 pc)	010968 ø 6 (1 pc)
010967 ø 5 (1 pc)	010970 ø 6,3 (1 pc)
010983 6,3x0,8 (100 pcs)	010980 M4x12 (100 pcs)
010989 M5x16 (100 pcs)	010975 M6x20 (100 pcs)
010988 M6 (5 pcs)	010984 M4x12 (100 pcs)

Inox

Consumabili - Consumables

010984 M4x12 (100 pcs)	(M4)
Perno filettato Thread rivets	



STUD SW 15 Alu LAB

011213 Kit pinze - Clamps kit

010965 \varnothing 3 (1 pc)



010968 \varnothing 6 (1 pc)



010967 \varnothing 5 (1 pc)



010970 \varnothing 6,3 (1 pc)



010986 (M4) (5 pcs)



010987 (M5) (5 pcs)



010988 (M6) (5 pcs)



Anello di tiro
Thread washers



0110079 Kit tiro - Traction kit

010966 \varnothing 4 (1 pc)



010059 M4x16 (100 pcs)



010986 M4 (5 pcs)



010980 M4x12 (100 pcs)



011063 250 mm (1 pc)



Leve a tirare - Multihook level

010200 850 mm
KPSH1 KIT Traversa
KPSH1 KIT Levelling bar

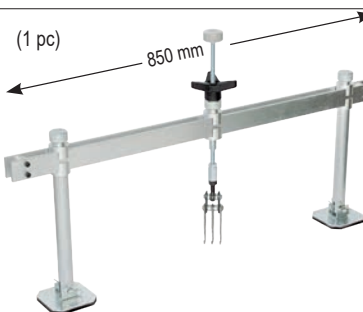

010312 700 mm
KPSL1 Leva a tirare
KPSL1 Multihook lever

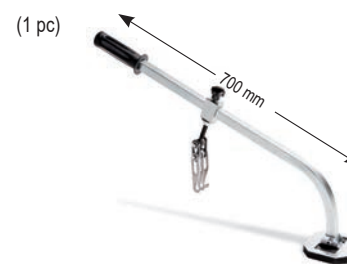

011044 250 mm
Traversa
Levelling bar

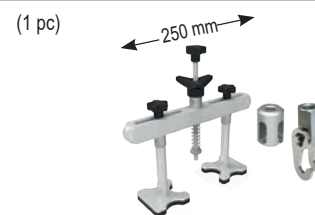

011063 250 mm (1 pc)

011064 500 mm (1 pc)

Perno di tiro
Traction rod



011045
Set martelli alluminio
Aluminum hammers kit



010889
Carrello CR28
CR28 Trolley





Kit Bracci - Kit Arms SW 100 LAB

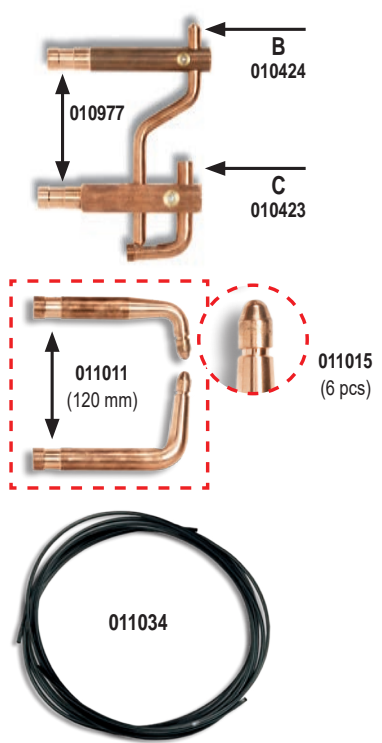
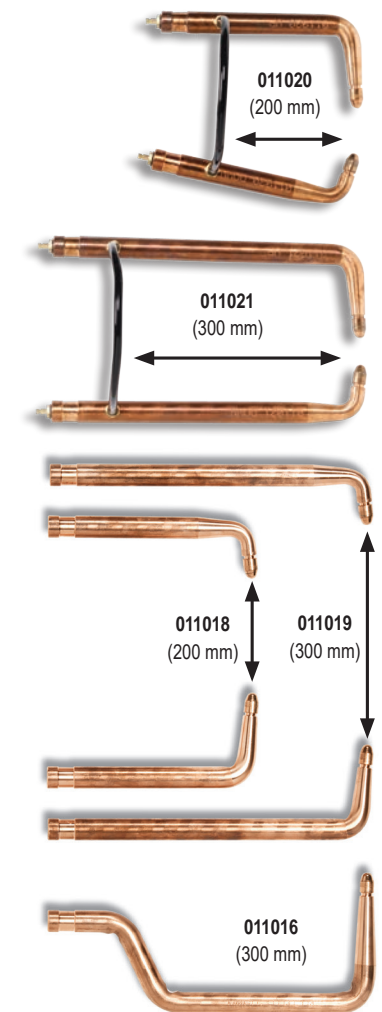

010063 KIT Bracci Acqua - Kit Arms Water Cooled Gun

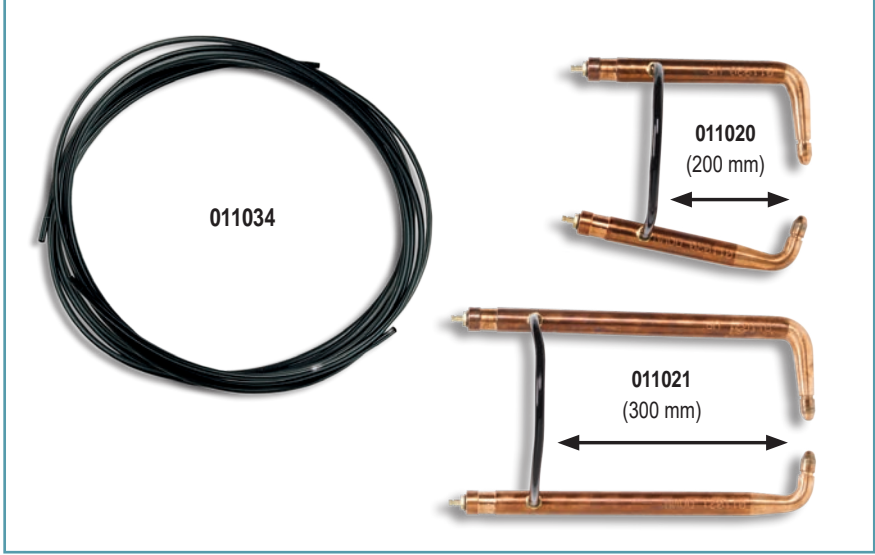

010639
Impianto raffreddamento WU18
WU18 Water cooling unit

010941 KIT Bracci Aria - Kit Arms Air Cooled Gun

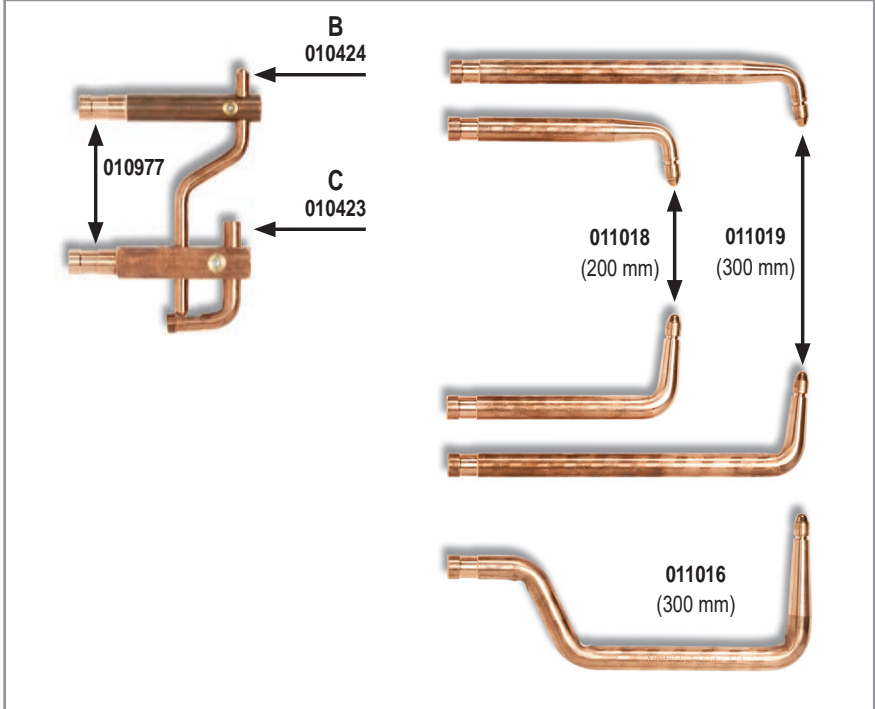

Accessori Accessories



019001 Blister Displayer Concept
100 x 50 x 201,5 cm



019004 Displayer Concept
66 x 47 x 102 cm
3 ripiani - 3 shelves

Punto Vendita / POP



Presentare il prodotto

Questi prodotti sono in confezione da espositore

Exposing the product

These products are in display pack

Maschere per saldatura con filtro auto-oscurante

Welding helmets with Auto Darkening Filter

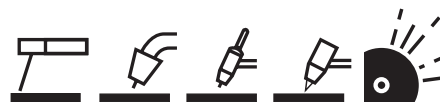

DIN 5-9 / 9-13

WM 40TC

- MMA
- MIG
- TIG
- PAC
- GRIND

Livello di sensibilità regolabile per un migliore rilevamento dell'arco
 Sensori: 4
 Delay Time regolabile
 Schermo di grandi dimensioni
 Adatta per: MMA, MIG, TIG, PAC, GRIND

Adjustable sensitivity level for a better arc detection
 Sensors: 4
 Adjustable Delay Time
 Extra large screen
 Suitable for: MMA, MIG, TIG, PAC, GRIND



DIN 5-9 / 9-13

WM 35TC

- MMA
- MIG
- TIG
- PAC
- GRIND

Livello di sensibilità regolabile per un migliore rilevamento dell'arco
 Sensori: 4
 Delay Time regolabile
 Schermo di grandi dimensioni
 Adatta per: MMA, MIG, TIG, PAC, GRIND

Adjustable sensitivity level for a better arc detection
 Sensors: 4
 Adjustable Delay Time
 Extra large screen
 Suitable for: MMA, MIG, TIG, PAC, GRIND



DIN 9-13

WM 31TC

- MMA
- MIG
- TIG
- GRIND

Livello di sensibilità regolabile per un migliore rilevamento dell'arco
 Sensori: 2
 Delay Time regolabile
 Schermo di grandi dimensioni
 Adatta per: MMA, MIG, TIG, GRIND

Adjustable sensitivity level for a better arc detection
 Sensors: 2
 Adjustable Delay Time
 Extra large screen
 Suitable for: MMA, MIG, TIG, GRIND





DIN 9-13

WM 27

MMA

MIG

TIG

Livello di sensibilità regolabile per un migliore rilevamento dell'arco

Sensori: 2

Delay Time regolabile

Adatta per: MMA, MIG, TIG

Adjustable sensitivity level for a better arc detection.

Sensors: 2

Adjustable Delay Time

Suitable for: MMA, MIG, TIG



DIN 11

WM 24

MMA

MIG

TIG

Sensori: 2

Adatta per: MMA, MIG, TIG (> 30Amp)

Sensori: 2

Suitable for: MMA, MIG, TIG (> 30Amp)



	WM 24	WM 27	WM 31TC	WM 35TC	WM 40TC
Campo di visuale - Viewing Area	90 x 34 mm	93 x 43 mm	93 x 43 mm	100 x 60 mm	100 x 83 mm
Colori reali - True colour			•	•	•
Sensori d'arco - Arc Sensor	2	2	2	4	4
Posizione chiara: grado di protezione - Light State: Shade	DIN 3	DIN 4	DIN 4	DIN 4	DIN 4
Posizione scura: grado di protezione - Dark State: Shade	DIN 11	DIN 9-13	DIN 9-13	DIN 5-9 / 9-13	DIN 5-9 / 9 - 13
Accensione / spegnimento automatico Automatic Power On / Off	•	•	•	•	•
Alimentazione - Power Supply	☀ + 🔋	☀ + 🔋	☀ + 🔋 (CR2450)	☀ + 🔋 (CR2450)	☀ + 🔋 (CR2450)
Tempo di commutazione da Chiaro a Scuro (Delay time da Scuro a Chiaro) Switching Time from Light to Dark (Delay time from Dark to Light)	5/10,000s (0.2s)	3/10,000s (0.1 ~ 0.8s)	3 / 10,000s (0.1 ~ 0.8s)	1/10,000s (0.1 ~ 0.8s)	1/10,000s (0.1 ~ 0.8s)
Classe ottica - Optical class	1/1/1/3	1/1/1/2	1/1/1/1	1/1/1/1	1/1/1/1
Smerigliatura - Grind			•	•	•
Taglio - Cut				•	•
Temperatura di esercizio - Operating Temp.	-5°C ~ +55°C	-5°C ~ +55°C	-5°C ~ +55°C	-5°C ~ +55°C	-5°C ~ +55°C
Peso - Weight	460 gr	500 gr	500 gr	556 gr	584 gr
Codice - Code	010402	010404	010408	010412	010414

Optionals

Protezione filtro esterna - Front cover filter (2 pcs)	010381 118 x 95 x 1 mm	010365 110 x 90 x 1 mm	010365 110 x 90 x 1 mm	010382 138 x 122 x 1 mm	010382 138 x 122 x 1 mm
--	----------------------------------	----------------------------------	----------------------------------	-----------------------------------	-----------------------------------

🔋 Batteria non sostituibile - No replaceable battery

Maschere per saldatura con filtro inattinico

Welding masks with adiacinic filter



WM 18

Valore di filtro scuro: fisso 11
Adatta per: MMA, MIG, TIG (> 20Amp)
Resistenza agli urti EN 175: SW

Single dark shade of 11
Suitable to: MMA, MIG, TIG (> 20Amp)
Impact resistance EN 175: SW



WM 19

Schermo in fibra. Senza vetri
Dimensioni vetro 75 x 98 mm.
Adatta per: MMA, MIG, TIG (> 20Amp)
Resistenza agli urti EN 175: SW

Pressed fiber handshield. Without glasses
Glass dimensions 75 x 98 mm.
Suitable to: MMA, MIG, TIG (> 20Amp)
Impact resistance EN 175: SW



WM 20

Valore di filtro scuro: fisso 11
Adatta per: MMA, MIG, TIG (> 20Amp)
Resistenza agli urti EN 175: SW

Single dark shade of 11
Suitable to: MMA, MIG, TIG (> 20Amp)
Impact resistance EN 175: SW

	WM 18	WM 19	WM 20
Campo di visuale - Viewing Area	75 x 98 mm	75 x 98 mm	75 x 98 mm
Posizione scura: grado di protezione - Dark State: Shade	DIN 11	-	DIN 11
Protezione UV/IR - UV/IR Protection	Superiore al grado di protezione DIN 16 in tutte le condizioni - Up To Shade DIN 16 at all time		
Temperatura di esercizio - Operating Temp.	-5°C ~ +55°C	-5°C ~ +55°C	-5°C ~ +55°C
Temperatura di stoccaggio - Storing Temp.	-20°C ~ +70°C	-20°C ~ +70°C	-20°C ~ +70°C
Peso - Weight	380 gr	240 gr	430 gr
Codice - Code	010319	010336	010320
Accessori - Accessoires			
Vetro trasparente - Transparent glass (4 pcs)	010338 75 x 98 x 2 mm	010338 75 x 98 x 2 mm	010338 75 x 98 x 2 mm
Vetro inattinico - Adiacinic glass DIN 11 (2 pcs)	010339 75 x 98 x 3 mm	010339 75 x 98 x 3 mm	010339 75 x 98 x 3 mm

Abbigliamento di protezione

Protective clothing



Cuffia cotone ignifugo
Fireproof cotton cap
010888

Chiusura regolabile in velcro.
Adjustable velcro strap.



Grembiule in crosta 60x90
Crust leather apron 60x90
010847 taglia - size L

In crosta con doppie cuciture in kevlar, taschino, lacci in nylon con ganci automatici.
Double kevlar seams, pocket, nylon laces with automatic hooks.



Guanti saldatura in crosta
Crust leather welding gloves
010963 taglia - size 10

In crosta con cuciture in kevlar, foderato in cotone, rinforzi sul palmo e pollice.
Kevlar seams, internal cotton padding, palm and thumb fold reinforcement.



Elettrodi rutili per acciai non legati e basso legati.

Innesco facile. Ottimo aspetto del cordone e facile rimozione della scoria.

Settori applicativi

Costruzioni metalliche in genere. Carpenteria leggera. Riparazioni.

Rutile electrodes for unalloyed and low alloyed steels.

Easy initiation. Excellent bead appearance and easy slag removal.

Main application

General structural work. Light carpentry. Repairing.

Codice Code	Diametro Diameter	Lunghezza Length	Quantità Quantity	Intensità corrente Current intensity	Classificazione Classification	Posizioni di saldatura Welding position	Tipo di corrente Type of current
Elettrodo rutilico Rutile electrode					AWS A5.1 E6013 EN 499 E 42 0 RR 12		
010220	1,6 mm	300 mm	40	20 - 40 A			
010224	1,6 mm	300 mm	100	20 - 40 A			
010221	2,0 mm	300 mm	40	40 - 60 A			
010225	2,0 mm	300 mm	80	40 - 60 A			
010112	2,0 mm	300 mm	400	40 - 60 A			
010222	2,5 mm	300 mm	30	60 - 90 A			
010125	2,5 mm	300 mm	55	60 - 90 A			
010113	2,5 mm	300 mm	275	60 - 90 A			
010223	3,2 mm	350 mm	16	90 - 120 A			
010126	3,2 mm	350 mm	30	90 - 120 A			
010114	3,2 mm	350 mm	145	90 - 120 A			
011043	4,0 mm	350 mm	95	120 - 180 A			

Elettrodi basici a basso contenuto di idrogeno.

Fusione senza spruzzi. Innesco abbastanza facile. Deposito regolare. Facile da pulire.

Settori applicativi

Elettrodi per applicazioni dove sono richieste ottime proprietà meccaniche.

Basic electrodes (low hydrogen).

Melting without spatter. Quite easy initiation. Regular cords. Easy cleaning.

Main application

Electrodes for applications requiring high mechanical strength.

Elettrodo basico Basic electrode	Diametro Diameter	Lunghezza Length	Quantità Quantity	Intensità corrente Current intensity	Classificazione Classification	Posizioni di saldatura Welding position	Tipo di corrente Type of current
Elettrodo basico Basic electrode					AWS A5.1: E 7018-1 ISO 2560-A-E463B42H5		
010127	2,5 mm	350 mm	30	70 - 90 A			
011040	2,5 mm	350 mm	230	70 - 90 A			
011042	3,2 mm	350 mm	30	110 - 140 A			
011041	3,2 mm	350 mm	140	110 - 140 A			

Elettrodi rutili per acciai inox (19Cr-10Ni).

Fusione senza spruzzi. Deposito regolare. Facile da pulire.

Settori applicativi

Utilizzato per la saldatura dell'acciaio inox tipo AISI 304 ed in tutte le costruzioni dove è richiesta una buona resistenza alla corrosione ed ossidazione.

Rutile electrodes for stainless steel (19Cr-10Ni).

Melting without spatter. Regular cords. Easy cleaning.

Main application

Used for welding of stainless steel AISI 304 and in all constructions which require a good resistance to corrosion and oxidation.

Elettrodo acciaio inox Stainless steel electrode	Diametro Diameter	Lunghezza Length	Quantità Quantity	Intensità corrente Current intensity	Classificazione Classification	Posizioni di saldatura Welding position	Tipo di corrente Type of current
Elettrodo acciaio inox Stainless steel electrode					AWS A5.4 E 308L-17 EN 1600 E 19 9 LR 32		
010128	2,0 mm	300 mm	40	35 - 50 A			
011039	2,0 mm	300 mm	178	35 - 50 A			
010129	2,5 mm	300 mm	30	50 - 80 A			
010115	2,5 mm	300 mm	102	50 - 80 A			

Elettrodo con rivestimento basico-grafitico per saldare ghisa senza o con basso preriscaldamento (300°C).

Per riparazioni di pezzi in ghisa o per unire pezzi in acciaio rame o nickel alle fusioni. Innesco facile. Superficie del cordone liscia.

Settori applicativi

Riparazioni.

Basic-graphite coated MMA electrode with a pure nickel core wire for welding cast iron without or with low preheating (max. +300°C).

For repair welding of cracked cast iron parts or joining components made of steel, copper or nickel materials to casting. Easy arc striking and restriking. Smooth bead surface.

Main application

Repairing.

Elettrodo ghisa Cast iron electrode	Diametro Diameter	Lunghezza Length	Quantità Quantity	Intensità corrente Current intensity	Classificazione Classification	Posizioni di saldatura Welding position	Tipo di corrente Type of current
Elettrodo ghisa Cast iron electrode					AWS A5.15 Eni-CI EN 1071 E C Ni-CI 1		
010131	2,5 mm	300 mm	6	60 - 90 A			
010130	2,5 mm	300 mm	16	60 - 90 A			

Kit di saldatura MMA - MMA Welding Kit							A	B	C	D
Modello Model	DS10 000200	DS16 000201	DS20 000217	DS35 000205	DS50 000207	DS60 000209	Porta elettrodi Electrode holder	Morsetto massa Earth clamp	Cavo Cable	Attacchi Socket
SIL 208	-	-	-	-	-	-	010301	010310	-	-
SIL 313	•	-	-	-	-	-	010301	010310	010353	010385
SIL 415	•	-	-	-	-	-	010301	010310	010353	010385
SIL 417	-	•	-	-	-	-	010303	010311	010357	010385
SIL 417 GEN	-	•	-	-	-	-	010303	010311	010357	010385
i-ARC 215	-	•	-	-	-	-	010303	010311	010358	010385
i-ARC 216D	-	•	-	-	-	-	010303	010311	010358	010385
i-ARC 217	-	•	-	-	-	-	010303	010311	010358	010385
i-ARC 318 LAB Evo	-	-	•	-	-	-	010303	010311	010358	010385
i-ARC 320 LAB Evo	-	-	•	-	-	-	010303	010311	010358	010385
i-ARC 319C LAB	-	-	•	-	-	-	010303	010311	010358	010385
i-ARC 525 LAB	-	-	-	•	-	-	010307	010315	010359	010386
i-ARC 530 C LAB	-	-	-	•	-	-	010307	010315	010306	010385
Globus 3.0	-	-	-	-	-	-	010301	010310	-	-
Globus 4.0	-	-	-	-	-	-	010301	010310	-	-
Globus 5.0 D	-	•	-	-	-	-	010303	010311	010357	010385
T-Arc 525 LAB	-	-	•	-	-	-	010303	010311	010358	010385
T-Arc 527 LAB	-	-	•	-	-	-	010303	010311	010358	010385
T-Arc 530 LAB	-	-	-	•	-	-	010307	010315	010359	010386
P-Arc 525 LAB	-	-	•	-	-	-	010303	010311	010358	010385
P-Arc 735 LAB	-	-	-	•	-	-	010307	010315	010359	010386
P-Arc 840 LAB	-	-	-	-	•	-	010304	010317	010360	010387
E-Arc 860 LAB	-	-	-	-	-	•	010306	010317	010361	010387



Kit saldatura
Welding Kit

DS10 160A 3+2m 10 mm² 25 000200



Kit saldatura
Welding Kit

DS16 180A 3+2m 16mm² 25 000201
 DS20 200A 3+2m 25mm² 25 000217
 DS35 350A 3+3m 35mm² 50 000205
 DS50 500A 3+3m 50mm² 70 000207
 DS60 600A 3+3m 70mm² 70 000209



Pinze porta elettrodi
Electrode holders

(a) 160A	200A@35%	010301	☉
(b) 200A	200A@35%	010303	☉
(c) 300A	300A@35%	010307	
(c) 400A	400A@35%	010304	
(c) 600A	600A@35%	010306	



Morsetti di massa
Earth clamps

(a) 160A		010310	☉
(b) 200A	200A@35%	010311	☉
(c) 350A	350A@35%	010315	
(d) 500A	500A@35%	010317	



Cavo
Cable

10 mm ² (10m)	010353
16 mm ² (10m)	010357
25 mm ² (10m)	010358
35 mm ² (10m)	010359
50 mm ² (10m)	010360
70 mm ² (10m)	010361



Attacchi
Sockets

25 mm ²	(2 pcs)	010385	☉
50 mm ²	(2 pcs)	010386	
70 mm ²	(2 pcs)	010387	



Posizionatore magnetico
Magnetic position holder

(a) MPH 92	010346	☉
(b) MPH 62	010345	☉



Spazzola
Brush

(a)	010342	☉
(b)	010343	☉



Martellina battiscoria
Hammer

010341 ☉

MMA Accessori - MMA Accessories



Cavo con pinza portaelettrodo
Cable with electrode holder

160A	10 mm ² (1,7m)	25 mm ²	010060
200A	16 mm ² (2,7m)	25 mm ²	010069
200A	25 mm ² (2,7m)	25 mm ²	010834
300A	35 mm ² (3,0m)	50 mm ²	010070



Cavo con morsetto di massa
Cable with earth clamp

200A	16 mm ² (2,7m)	25 mm ²	010173
200A	25 mm ² (2,7m)	25 mm ²	010833
350A	35 mm ² (3,0m)	50 mm ²	010314
500A	70 mm ² (3,0m)	70 mm ²	010316



Adattatore
Adapter

25 mm ² <-> 50 mm ²	010820
---	--------



Accessori gas - Gas accessories

Riduttori di pressione - Pressure reducers		Codice - Code	Codice - Code
	Bombole non ricaricabili Not refillable bottles (M10) CO ₂ / Argon / Mix	010515	Riduttore di pressione 1 manometro Pressure reducer with 1 manometer (Gas ø 6,5 IT / USA)
	Riduttore di pressione / Pressure reducer (Gas ø 6,5 IT / USA)	010499	Riduttore pressione + adattatore CO ₂ >Argon Pressure reducer + adapter CO ₂ >Argon
	Riduttore pressione + adattatore CO ₂ >Argon Pressure reducer + adapter CO ₂ >Argon	010835	Riduttore di pressione 2 manometri Pressure reducer with 2 manometers (Gas ø 6,5 IT / USA)
	Riduttore di pressione 2 manometri Pressure reducer with 2 manometers (Gas ø 6,5 IT / USA)	010242	Riduttore pressione + adattatore CO ₂ >Argon Pressure reducer + adapter CO ₂ >Argon
	Riduttore pressione + adattatore CO ₂ >Argon Pressure reducer + adapter CO ₂ >Argon	010832	Riduttore pressione manometro / flussometro Manometer / flowmeter pressure reducer (Gas ø 6,5 IT / USA)
	Adattatore gas / Gas adapter CO ₂ ⇌ Ar	010571	Riduttore pressione + adattatore CO ₂ >Argon Pressure reducer + adapter CO ₂ >Argon



Adattatore bombole ricaricabili/non ricaricabili
Adapter for refillable bottle/non refillable bottle

010810



Tubo gas
Gas Hose

1,5m 000216



Bombole non ricaricabili
Not refillable bottles

CO ₂	lt. 1	(1 pc)	010501
Argon / CO ₂	lt. 1	(1 pc)	010502
Argon	lt. 1	(1 pc)	010503



Spray anti aderente
Anti Stick Spray

010621

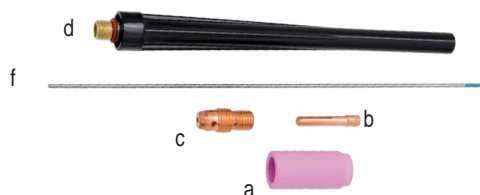
Torche TIG e dotazione - TIG torches and equipment
Codice - Code
Codice - Code

TG9V Valve

- | | | |
|---|----------|--------|
| ■ Ugello gas - Gas nozzle No.6 (a) | (10 pcs) | 010656 |
| ■ Pinze serra elettrodo - Electrode holder Fe ø 1,6 (b) | (3 pcs) | 010658 |
| ■ Diffusore gas - Gas diffuser ø 1,6 (c) | (3 pcs) | 010657 |
| ■ Cappuccio lungo - Long cap (d) | (3 pcs) | 010655 |
| ■ Elettrodo - Electrode Fe ø 1,6 (f) | (10 pc) | 010694 |

110A

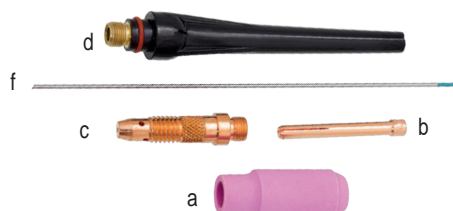
TG9V Valve 3 m - 25 mmq **010614**
SILTIG 415
OPTIONAL: SIL Series - i-ARC 2 Series - i-ARC 3 Series

TG17V - ET17 - ET26 - ET18

- | | | |
|--|----------|--------|
| ■ No.6 | (10 pcs) | 010690 |
| ■ No.8 | (10 pcs) | 010691 |
| ■ No.10 | (10 pcs) | 010692 |
| | | |
| ■ Pinze serra elettrodo - Electrode holder (b) | | |
| ø 1,6 | (3 pcs) | 010633 |
| ø 2,4 | (3 pcs) | 010635 |
| ø 3,2 | (3 pcs) | 010636 |
| ø 4,0 | (3 pcs) | 010661 |
| | | |
| ■ Diffusore gas - Gas diffuser (c) | | |
| ø 1,6 | (3 pcs) | 010645 |
| ø 2,4 | (3 pcs) | 010643 |
| ø 3,2 | (3 pcs) | 010644 |
| ø 4,0 | (3 pcs) | 010660 |
| | | |
| ■ Cappuccio lungo - Long cap (d) | (3 pcs) | 010369 |
| | | |
| ■ Elettrodo - Electrode (f) | | |
| Fe ø 1,6 | (10 pc) | 010694 |

140A

TG17V Valve 4 m - 50 mmq **010825**
OPTIONAL: i-ARC 525 - Easy JOB 525E - JOB 635 - JOB 735
TG17V Valve 4 m - 25<>50 mmq **010068**
OPTIONAL: i-ARC 2 Series - i-ARC 3 Series - MIGA Series - JOB Series - EasyJob 520

140A



ET17 4 m - 25 mmq "Tyco" **010782**
MASTROTIG 218 AC - MASTROTIG 216 AC/DC
ET17 4 m - 25 mmq "DIN 5" **010784**
i TIG Series



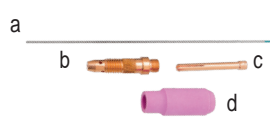
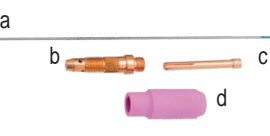

180A

ET26 4 m - 50 mmq "Tyco" **010789**
ET26 8 m - 50 mmq "Tyco" **010804**
OPTIONAL: MASTROTIG 327 - MASTROTIG 330
ET26 4 m - 50 mmq "XLR" **010785**
ET26 8 m - 50 mmq "XLR" **010807**
OPTIONAL: E-ARC 860

**320A
H2O**

ET18 H2o 4 m - 50 mmq "Tyco" **010514**
ET18 H2o 8 m - 50 mmq "Tyco" **010519**
OPTIONAL: MASTROTIG 327 - MASTROTIG 330

Starter kit per Torce TIG - TIG torches starter kit		Codice - Code	
Torce / Torches: 140Amp, 180Amp, 320Amp			
	STARTER KIT Ø 2,4 acciaio-steel	010072	
	Ugello - Nozzle No.6 1 pc (d) Pinza serra elettrodo - Electrode holder ø 2,4 1 pc (c) Diffusore gas - Gas diffuser ø 2,4 1 pc (b) Elettrodo - Electrode WC20 ø 2,4 1 pc (a)		
	STARTER KIT Ø 2,4 / 3,2 acciaio-steel Ø 1,6 / 2,4 / 3,2 alluminio-aluminum	010083	
	Ugello - Nozzle No.8 1 pc (d) Pinze serra elettrodo - Electrode holders: ø 2,4 - 3,2 1 pc/cad (c) Diffusori gas - Gas diffusers: ø 2,4 - 3,2 1 pc/cad (b) Elettrodi - Electrodes WC20 ø 2,4 - 3,2 1 pc/cad (a) Elettrodi - Electrodes WP: ø 1,6 - 2,4 - 3,2 1 pc/cad (a)		
Torcia / Torch: 110Amp			
	STARTER KIT	011265	
	Torcia - Torch TG9V Valve 3 m (010614) Bacchette TIG / TIG rods L. 330mm Kg 0,33 Inox 308L 1,6mm (011264) Adattatore bombola non ricaricabile - Adapter not refillable bottle (010810) Regolatore di pressione - Pressure regulator (M10) (010515)		

Elettrodi tungsteno per torce TIG - TIG torches tungsten electrodes		Codice - Code							
		Diametro Diameter	Intensità corrente Current intensity	Quantità Quantity	Codice Code	Gas	Metalli Metals	Corrente Current	
	WC20 Tungsteno/Cerio 2% - Tungsten/Cerium 2%								
	WC20	ø 1,6	10 - 80 A	10 pcs	010694	Argon	Acciaio Inox Steel Stainless		
	WC20	ø 2,4	90 - 120 A	10 pcs	010696				
	WC20	ø 3,2	125 - 240 A	10 pcs	010668				
	WC20	ø 4,0	125 - 240 A	10 pcs	010663				
	WP Tungsteno puro - Pure Tungsten								
	WP	ø 1,6	40 - 80 A	10 pcs	010697	Argon	Leghe Leggere Light Alloys		
	WP	ø 2,4	70 - 120 A	10 pcs	010699				
	WP	ø 3,2	125 - 240 A	10 pcs	010700				
WP	ø 4,0	125 - 240 A	10 pcs	010662					

Bacchette TIG - TIG filler rods		Codice - Code				
		Diametro Diameter	Lunghezza Length	Quantità Quantity	Codice Code	
	Inox - Stainless steel					
	308L	ø 1,6	1000 mm	1,0 kg	011255	
	308L	ø 1,6	330 mm	0,33 kg	011264	
	316L	ø 1,6	1000 mm	1,0 kg	011256	
	309L	ø 1,6	1000 mm	1,0 kg	011257	
	AlMg5 / AISi5					
	AlMg5	ø 1,6	1000 mm	1,0 kg	011258	
AISi5	ø 1,6	1000 mm	1,0 kg	011259		

Torçe MIG e dotazione -MIG torches and equipment

Codice - Code

Codice - Code

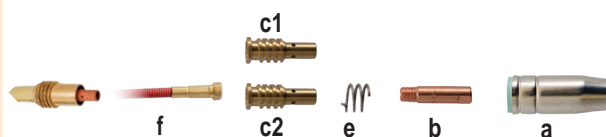

DE 140 valve - MIG 140A - MIG 140A valve - MIG160A

Ugello gas - Gas nozzle	(a)		
■ ø 12mm		(5 pcs)	010443
■ ø 12mm		(2 pcs)	010252
Ugello portacorrente - Contact tip	(b)		
Fe ø 0,6 M6 25mm		(20 pcs)	010448
Fe ø 0,8 M6 25mm		(20 pcs)	010449
■ Fe ø 1,0 M6 25mm		(20 pcs)	010450
Diffusore gas - Gas diffuser	(c)		
■ M6 MIG 110A valve	(c1)	(10 pcs)	011089
■ M6 MIG 140A - 140A valve - 160A	(c2)	(10 pcs)	011088
■ Molla - Spring	(e)	(10 pcs)	010437
Guaina guidafile - Liner	(f)		
■ Fe, Flux ø 0,6 / 1,0		(1 pc)	010241



DE15E - DE M15A - EP15grip - EP15 CuSi3 - EP15

Ugello gas - Gas nozzle	(a)		
■ ø 12		(5 pcs)	010443
Ugello portacorrente - Contact tip	(b)		
Fe ø 0,6 M6 25mm		(20 pcs)	010448
■ Fe ø 0,8 M6 25mm		(20 pcs)	010449
Fe ø 1,0 M6 25mm		(20 pcs)	010450
Fe ø 1,2 M6 25mm		(20 pcs)	010451
Diffusore gas - Gas diffuser	(c)		
■ M6		(10 pcs)	010803
■ Molla - Spring	(e)	(10 pcs)	010437
Guaina guidafile - Liner	(f)		
■ Fe ø 0,6 / 0,9 DE M15A - EP15 GRIP - EP15		(1 pc)	010743
■ Fe ø 1,0 / 1,2 DE 15E		(1 pc)	010744
■ Tefon ø 1,0 / 1,2 EP 15 CUSI3		(1 pc)	010856

Torcia fornita con 1 pc/cad - Torch supplied with 1 pc/each



DE 140 Valve 2 m - 110 @ 35%
MIGA 200 - MIGA 215



110A



MIG 140A 2 m - 140 @ 60%
D-mig 230 AC



140A



MIG 140A Valve 2 m - 140 @ 60%
D-mig 235



140A



MIG 160A 2 m - 160 @ 60%
D-mig 380



160A



DE 15E 3 m 180 @ 60% EURO
MIGA 218 - 220 - 225XL - 320 - 380 - D-mig 420s

010822

180A



DE M15A 3 m - 180 @ 60% EURO
JOB Series - EasyJob 220 - 221XL - 520

010583

180A



EP 15 GRIP 3 m - 180 @ 60% EURO
EP 15 GRIP 4 m - 180 @ 60% EURO

010507

010508

180A



SPECIAL
CuSi3

EP 15 CuSi3 3 m - 180 @ 60% EURO
JOB Trio 220

010071

180A



SPECIAL
Fe

EP 15 3 m - 180 @ 60% EURO
Job Duo 220 - Job Trio 220

010234

Torçe MIG e dotazione - MIG torches and equipment

Codice - Code

Codice - Code

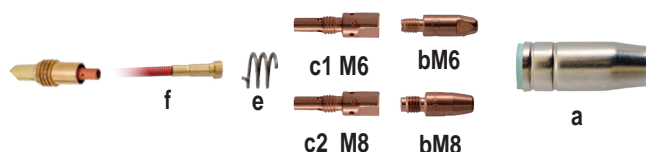

DE 25E - DE M25A

■ Ugello gas - Gas nozzle	(a)	(5 pcs)	010444
ø 15			
■ Ugello portacorrente - Contact tip	(b)		
■ Fe ø 0,8 M6 28mm DE25E		(20 pcs)	010864
■ Fe ø 1,0 M6 28mm DE M25A		(20 pcs)	010942
■ Fe ø 1,2 M6 28mm		(20 pcs)	010943
■ Diffusore gas - Gas diffuser			
M6 35mm	(c1)	(10 pcs)	010997
■ Molla - Spring	(e)	(10 pcs)	010436
■ Guaina guidafile - Liner	(f)		
■ Fe ø 1,0/1,2		(1 pc)	010744



230A

DE 25E 3 m - 230 @ 60% EURO 010828

EP 25 Grip

■ Ugello gas - Gas nozzle	(a)	(5 pcs)	010444
ø 15			
■ Ugello portacorrente - Contact tip	(b)		
■ Fe ø 0,8 M6 28mm		(20 pcs)	010864
■ Fe ø 1,0 M6 28mm		(20 pcs)	010942
■ Fe ø 1,2 M6 28mm		(20 pcs)	010943
■ Fe ø 1,6 M6 28mm		(20 pcs)	010944
■ Diffusore gas - Gas diffuser (c)			
M6 35mm	(c1)	(10 pcs)	010997
M8 35mm	(c2)	(10 pcs)	010868
■ Molla - Spring	(e)	(10 pcs)	010436
■ Guaina guidafile - Liner	(f)		
■ Fe ø 1,0/1,2		(1 pc)	010744



230A

DE M25A 3 m - 230 @ 60% EURO 010584
EasyJob 525E

EP 25 ALU

■ Ugello gas - Gas nozzle	(a)	(5 pcs)	010444
ø 15			
■ Ugello portacorrente - Contact tip	(b)		
■ ALU ø 0,8 M6 28mm		(20 pcs)	010949
■ ALU ø 1,0 M6 28mm		(20 pcs)	010992
■ ALU ø 1,2 M6 28mm		(20 pcs)	010993
■ Diffusore gas - Gas diffuser	(c)		
M6 35mm		(10 pcs)	010997
■ Molla - Spring	(e)	(10 pcs)	010436
■ Guaina guidafile - Liner	(f)		
■ Teflon ø 1,0/1,2		(1 pc)	010384



230A

EP 25 GRIP 3 m - 230 @ 60% EURO 010576
EP 25 GRIP 4 m - 230 @ 60% EURO 010577



230A

EP 25 ALU 3 m - 230 @ 60% EURO 010074
Job Duo 220 - Job Trio 220

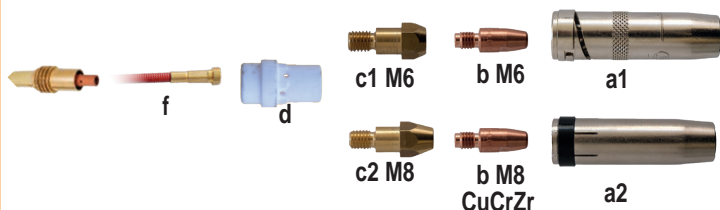
EP 36 GRIP

Ugello gas - Gas nozzle			
■	ø 16 quick release	(a1)	(5 pcs) 010445
	ø 16 (a2)	(a2)	(5 pcs) 011084
Ugello portacorrente - Contact tip			
	ø 1,0 M8 CuCrZr	(b)	(20 pcs) 010861
■	ø 1,2 M8 CuCrZr		(20 pcs) 010862
	ø 1,6 M8 CuCrZr		(20 pcs) 010863
Porta punta - Collet body nozzle			
■	M6 28mm	(c1)	(20 pcs) 011082
	M8 28mm	(c2)	(20 pcs) 010409
	M6 32mm	(c1)	(20 pcs) 010439
	M8 32mm	(c2)	(20 pcs) 011081
Diffusore gas - Gas diffuser			
	Plastica	(d)	(10 pcs) 010998
■	Ceramica		(10 pcs) 010869
Guaina guidafile - Liner			
■	Fe ø 1,0 / 1,2	(f)	(1 pc) 010744

EP 36 GRIP 3 m - 330 @ 60% EURO 010578
 EP 36 GRIP 4 m - 330 @ 60% EURO 010579

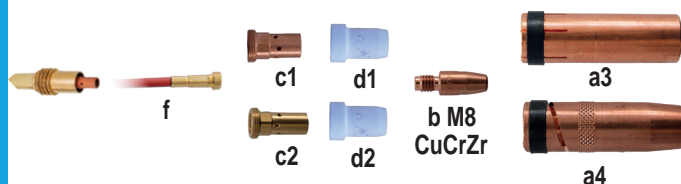
330A

EP 500 GRIP H2O

Ugello gas - Gas nozzle			
■	ø 20	(a3)	(10 pcs) 010406
	ø 16 quick release	(a4)	(10 pcs) 011085
Ugello portacorrente - Contact tip			
	ø 1,0 M8 CuCrZr	(b)	(20 pcs) 010861
■	ø 1,2 M8 CuCrZr		(20 pcs) 010862
	ø 1,6 M8 CuCrZr		(20 pcs) 010863
Porta punta - Collet body nozzle			
■	M8 rame 25mm	(c1)	(10 pcs) 011083
	M8 ottone 29mm	(c2)	(10 pcs) 010405
Diffusore gas - Gas diffuser			
	Plastica	(d1)	(10 pcs) 010999
■	Ceramica	(d2)	(10 pcs) 010870
Guaina guidafile nuda - Uncoated Liner			
■	Fe ø 1,2 / 1,6	(f)	(1 pc) 010859

EP 500A GRIP H2O 3 m - 500 @ 100% EURO 010580
 EP 500A GRIP H2O 4 m - 500 @ 100% EURO 010581

500A

Ugello portacorrente Acciaio - Contact tip Steel							Codice - Code	Torcia - Torch
		Ø	L.	Pcs.				
	Fe Inox	0,6	M6 - Cu	25 mm	(20 pcs)	010448	DE 140A DE 140A valve MIG 160A DE 15E DE M15A EP 15 Grip EP15 CuSi3	
	Fe Inox	0,8	M6 - Cu	25 mm	(20 pcs)	010449		
	Fe Inox	1,0	M6 - Cu	25 mm	(20 pcs)	010450		
	Fe Inox	1,2	M6 - Cu	25 mm	(20 pcs)	010451		
	Fe Inox	0,6	M6 - Cu	25 mm	(3 pcs) ☉	010253		
	Fe Inox	0,8	M6 - Cu	25 mm	(3 pcs) ☉	010254		
	Fe Inox	1,0	M6 - Cu	25 mm	(3 pcs) ☉	010255		
	Fe Inox	0,8	M6 - Cu	28 mm	(20 pcs)	010864	DE 25E DE M25A EP 25 Grip EP 25 ALU	
	Fe Inox	1,0	M6 - Cu	28 mm	(20 pcs)	010942		
	Fe Inox	1,2	M6 - Cu	28 mm	(20 pcs)	010943		
	Fe Inox	1,6	M6 - Cu	28 mm	(20 pcs)	010944		
	ALU	0,8	M6 - Cu	28 mm	(20 pcs)	010949		
	ALU	1,0	M6 - Cu	28 mm	(20 pcs)	010992		
	ALU	1,2	M6 - Cu	28 mm	(20 pcs)	010993		
	ALU	0,8	M6 - Cu	28 mm	(3 pcs) ☉	010256		
	ALU	1,0	M6 - Cu	28 mm	(3 pcs) ☉	010257		
	Fe Inox	0,8	M8 - Cu	30 mm	(20 pcs)	010945	DE 25E DE M25A EP 25 Grip EP 25 ALU	
	Fe Inox	1,0	M8 - Cu	30 mm	(20 pcs)	010946		
	Fe Inox	1,2	M8 - Cu	30 mm	(20 pcs)	010947		
	Fe Inox	1,6	M8 - Cu	30 mm	(20 pcs)	010948		
	ALU	1,0	M8 - Cu	30 mm	(20 pcs)	010994	EP 36 Grip EP 500 Grip H20	
	ALU	1,2	M8 - Cu	30 mm	(20 pcs)	010995		
	ALU	1,6	M8 - Cu	30 mm	(20 pcs)	010996		
	ALU / Fe Inox	1,0	M8 - CuCrZr	30 mm	(20 pcs)	010861		
	ALU / Fe Inox	1,2	M8 - CuCrZr	30 mm	(20 pcs)	010862		
	ALU / Fe Inox	1,6	M8 - CuCrZr	30 mm	(20 pcs)	010863		

Guaine guidafile - MIG liners							Codice - Code	Torcia - Torch
Liner Colour		Ø		L.				
	Fe, Flux	0,6 / 1,0	Acciaio rivestito Coated steel	3 m	010241	DE 110A valve DE 140A - DE 140A valve DE 160A		
	ALU	0,8 / 1,0	Teflon	3 m	010370			
	Fe	0,6 / 0,9	Acciaio rivestito Coated steel	4 m	010743			
	Fe	1,0 / 1,2	Acciaio rivestito Coated steel	4 m	010744	DE 15E DE M15A EP 15 Grip EP 15 CuSi3 DE 25E DE M25A EP 25 Grip EP 25 CuSi EP 36 Grip EP 500 Grip		
	Fe	1,2 / 1,6	Acciaio rivestito Coated steel	4 m	010745			
	Fe	1,2 / 1,6	Acciaio no rivestito Uncoated steel	4 m	010859			
	CuSi3	1,0 / 1,2	Acciaio + anima Teflon Steel + inner Teflon	4 m	010585			
	ALU	0,6 / 0,9	Teflon**	3 m	010746			
	ALU	1,0 / 1,2	Teflon**	3 m	010747			
	ALU / CuSi3	1,0 / 1,2	Teflon + terminale rame** Teflon + copper terminal**	4 m	010856			
	ALU	1,0 / 1,2	Teflon + 12% grafite + terminale rame Teflon + 12% graphite + copper terminal	4 m	010384			
	ALU	1,2 / 1,6	Teflon + 12% grafite + terminale rame Teflon + 12% graphite + copper terminal	4 m	010857			

** Tubo capillare incluso
** Capillary tube included

Fe = acciaio, steel ALU = alluminio, aluminum

Rullino trainafile - Wire guide roller		Ø mm		Codice - Code	
 Ø 25	Fe	0,8 / 1,0	(1 pc)	011251	MIGA 200, 215, 218, 220 MIGA 320
	Fe Flux	Fe: 0,6 Flux: 0,9	(1 pc)	011250	
	Al	0,8 / 1,0 / 1,2	(1 pc)	011252	
 Ø 30	Fe	0,6 / 0,8	(1 pc)	011214	MIGA 225XL MIGA 380 EasyJob 220, 221XL EasyJob 520, 525E
	Fe	1,0 / 1,2	(1 pc)	011215	
	Flux	0,9 / 1,0	(1 pc)	011218	
	Flux	1,0 / 1,2	(1 pc)	011219	
	Al	0,8 / 1,0	(1 pc)	011216	
	Al	1,0 / 1,2	(1 pc)	011217	
 Ø 37	Fe	0,6 / 0,8	(2 pcs)	011220	JOB 222PD JOB 522PD JOB DUO 220, TRIO 220 JOB 635 JOB 735
	Fe	1,0 / 1,2	(2 pcs)	011221	
	Flux	0,9 / 1,0 / 1,2	(2 pcs)	011224	
	Al	0,8 / 1,0	(2 pcs)	011222	
	Al	1,0 / 1,2	(2 pcs)	011223	
 Ø 37	Fe	0,8 / 1,0	(2 pcs)	011270	JOB 750
	Fe	1,2 / 1,6	(2 pcs)	011271	
	Flux	1,0 / 1,2	(2 pcs)	011273	
	Flux	1,2 / 1,6	(2 pcs)	011274	
	Al	1,2 / 1,6	(2 pcs)	011272	
 Ø 20	KIT: Fe Flux Al	Fe: 0,6 / 0,8 / 1,0 Flux: 0,8 / 0,9 / 1,2 Al: 0,8 / 1,0	Blister 3 pcs 	010841	D-mig 230AC D-mig 235, D- mig 380, 420S
	Fe	0,6	(1 pc)	010776	
	Flux	0,8 / 0,9 / 1,2	(1 pc)	010775	
	Fe / Al	0,8 / 1,0	(1 pc)	010673	
 Ø 30	Fe	0,6 / 0,8	(1 pc)	010647	D-mig 525T, 530SD, 532TDKE
	Fe	1,0 / 1,2	(1 pc)	010628	
	Flux	0,9	(1 pc)	010627	
	Al	0,8 / 1,0	(1 pc)	010629	
 Ø 30	Fe	0,8 / 1,0	(2 pcs)	011206	D- mig 735TD, 750TD, 760TD D- mig 635T, 635TD, 750T, 650TD
	Fe	1,2 / 1,6	(2 pcs)	011207	
	Flux	1,2 / 1,6	(2 pcs)	011210	
	Al	0,8 / 1,0	(2 pcs)	011208	
	Al	1,2 / 1,6	(2 pcs)	011209	

Starter kit per Torce MIG - MIG torches starter kit		Codice - Code	
	STARTER KIT ALLUMINIO Ø 1,0 EasyJob Series		010850
	1 x Guaina - Liner	Teflon/rame - teflon/copper	(010856)
	3 x Ugello portacorrente - Contact tip	Ø 1,0 M6 ALU	(010257)
	1 x Rullo trainafile Wire roller	Ø 1,0 / 1,2 ALU	(011217)
	STARTER KIT ALLUMINIO Ø 1,0 Job 222 PD - 522 PD		010851
	1 x Guaina - Liner	Teflon/rame - teflon/copper	(010856)
	3 x Ugello portacorrente - Contact tip	Ø 1,0 M6 ALU	(010257)
	2 x Rullo trainafile Wire roller	Ø 1,0 / 1,2	(011223)
	STARTER KIT ALLUMINIO Ø 1,2 Job 635 - 735		010853
	1 x Guaina - Liner	Teflon/rame - teflon/copper	(010856)
	20 x Ugello portacorrente - Contact tip	Ø 1,2 M6 ALU	(010993)
	20 x Ugello portacorrente - Contact tip	Ø 1,2 M8 ALU	(010995)
	2 x Rullo trainafile Wire roller	Ø 1,0 / 1,2	(011223)
	STARTER KIT ALLUMINIO Ø 1,0 D-mig 500 Series		010855
	1 x Guaina - Liner	Teflon/rame - teflon/copper	(010856)
	3 x Ugello portacorrente - Contact tip	Ø 1,0 M6 ALU	(010257)
	1 x Rullo trainafile Wire roller	Ø 0,8 / 1,0	(010629)



Acciaio

Di impiego generale, indicato per l'unione di acciai al carbonio comuni. Da impiegarsi nella carpenteria in genere, serbatoi, carrozzerie, ecc.

Steel

Suitable for the joint of unalloyed carbon steels. To be used for steel structures in general, carbody repair, tanks, etc.

Codice Code	Diametro Diameter	Bobina Spool	Quantità Quantity	Intensità corrente Current intensity	Gas di protezione Shielding gas	Classificazione Classification	Tipo di corrente Type of current
Acciaio - Steel							
010871	ø 0,6	ø 100 mm	0,7 kg	30 - 100 A	Argon/CO2 CO2	AWS A5.18: ER 70S-6 EN ISO 14341-A: G 42 2 M G3Si1	
010801	ø 0,6	ø 200 mm	5,0 kg	30 - 100 A			
010872	ø 0,8	ø 100 mm	0,7 kg	60 - 200 A			
010805	ø 0,8	ø 200 mm	5,0 kg	60 - 200 A			
010846	ø 1,0	ø 200 mm	5,0 kg	65 - 220 A			

Alluminio / Magnesio 5%

Filo pieno in alluminio indicato per la saldatura di leghe contenenti fino al 5% di magnesio. Trova impiego nella saldatura di strutture nel comparto navale, ferroviario, automotive e costruzioni di serbatoi.

Aluminum / Magnesium 5%

Solid aluminum wire suitable for welding alloys containing up to 5% magnesium, used in the construction of structures in shipbuilding, railways, automotive and tank sector.

Alluminio / Magnesio 5% - Aluminum / Magnesium 5%							
010881	ø 0,8	ø 100 mm	0,4 kg	60 - 170 A	Argon	AWS A5.10: ER 5356 EN ISO 18273: S Al 5356 (AlMg5Cr(A))	
010882	ø 1,0	ø 100 mm	0,4 kg	90 - 210 A			
010876	ø 1,0	ø 200 mm	2,0 kg	90 - 210 A			

Alluminio / Silicio 5%

Filo pieno in alluminio al 5% di Si. Indicato per la saldatura di leghe Al-Si 2-7%, e leghe Al-Mg-Si. Trova impiego nella costruzione di strutture per impieghi architettonici, cassoni per autotreni, serbatoi e per la riparazione di fusioni.

Aluminum / Silicon 5%

Solid aluminum wire with 5% Si. Suitable for welding Al Si 2-7% alloys, and Al-Mg-Si alloys. It is used in the construction of structures for architectonic uses, trailer-truck bodies, tanks and casting repair.

Alluminio / Silicio 5% - Aluminum / Silicon 5%							
010844	ø 1,0	ø 100 mm	0,5 kg	90 - 210 A	Argon	AWS A5.10: ER 4043 EN ISO 18273: S Al 4043 (AlSi5(A))	
010860	ø 1,0	ø 200 mm	2,0 kg	90 - 210 A			

Acciaio inox

Filo pieno idoneo alla saldatura di acciai inossidabili del tipo AISI 301, 304 e 304L. Ottima resistenza alla corrosione.

Stainless Steel

Solid wire suitable for welding stainless steels AISI 301, 304 and 304L type. Excellent resistance to corrosion.

Acciaio inox - Stainless steel							
010892	ø 0,8	ø 100 mm	0,7 kg	65 - 220 A	Argon Argon/O2	AWS A5.9: ER 308L Si EN ISO 14343-A: G 19 9 L Si	

Animato

Filo Animato autoprotetto multiposizionale ideale per saldature single-pass su acciaio al carbonio.

FLUX self-shielded

All positional self-shielded wire, ideal single-pass welding of carbon steel.

Animato - FLUX Self-shielded							
010818	ø 0,9	ø 100 mm	0,7 kg	40 - 100 A	-	AWS A5.20: E71T-GS	
010816	ø 0,9	ø 200 mm	2,0 kg	40 - 100 A			





Rame / Silicio 3%

Filo pieno idoneo alla saldatura di leghe rame-silicio o rame-zinco. Particolarmente indicato per la saldobrasatura delle lamiere zincate nel settore carrozzeria.

Copper / Silicon 3%

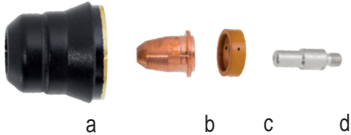
Solid wire suitable for welding of copper-zinc or copper-silicon. Particularly suitable for brazing of galvanized sheet metal in the bodywork.

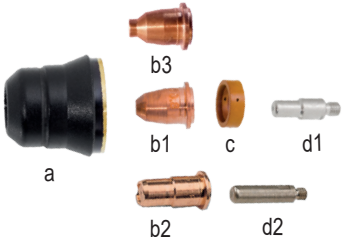
Rame / Silicio 3% - Copper / Silicon 3%							
010845	ø 0,8	ø 200 mm	2,0 kg	65 - 220 A	Argon	AWS A5.7: ER CuSi-A EN ISO 14640: S CuSi3Mn1 - S Cu6560	
010848	ø 0,8	ø 200 mm	5,0 kg	65 - 220 A			

Torce PAC e dotazione - PAC torches and equipment		Codice - Code		Codice - Code	
					
DE 25 - DE25K Porta ugello - Nozzle holder (a) (4 pcs) 010186 ■ 6 fori - 6 holes DE 25 (4 pcs) 010198 ■ 4 fori - 4 holes DE25K Ugello - Nozzle (b) (10 pcs) 010961 ∅ 0,6 mm 20A (10 pcs) 010183 ∅ 0,8 mm 30A ■ Diffusore aria-Swirl (c) (2 pcs) 010179 ■ Elettrodo-Electrode (d) (10 pcs) 010180				DE 25 PAC 4 m ✂ 40A I-PAC 340 DE 25K PAC 4 m ✂ I-PAC 335K	
					
DE 50 Porta ugello - Nozzle holder (a) (4 pcs) 010186 ■ 6 fori - 6 holes Ugello - Nozzle (b1) (10 pcs) 010961 ∅ 0,6 mm 20A (b1) (10 pcs) 010183 ∅ 0,8 mm 30A (b1) (10 pcs) 010123 ■ Lungo - Long ∅ 0,9 mm 50A (b2) (10 pcs) 010185 Gouging (b3) (10 pcs) 010525 Diffusore aria-Swirl (c) (2 pcs) 010179 Elettrodo-Electrode (d1) (10 pcs) 010180 ■ Lungo - Long (d2) (10 pcs) 010182				DE 50 PAC 4 m 010830 I-PAC 350 LAB 50A	

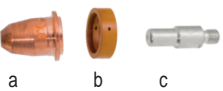
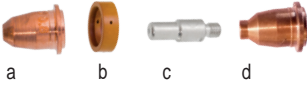
Starter kit per Torce PAC - PAC torches starter kit		Codice - Code	
Torcia - Torch DE 25 - DE25K			
	STARTER KIT Ugello-Nozzle ∅ 0,8 mm 30A (3pcs) (a) Diffusore aria-Swirl (1pc) (b) Elettrodo-Electrode (3pcs) (c)	010082	
Torcia - Torch DE 50			
	STARTER KIT Ugello-Nozzle ∅ 0,8 mm 30A (3pcs) (a) Ugello-Nozzle ∅ 0,9 mm 50A (3pcs) (a) Diffusore aria-Swirl (1pc) (b) Elettrodo-Electrode (3pcs) (c) Gouging (1pc) (d)	010084	

Torce PAC e dotazione - PAC torches and equipment		Codice - Code	Codice - Code	
TC70 - TC70A				
■ Elettrodo-Electrode 70A	(5 pcs)	010527	 <p>70A</p>	
Elettrodo lungo -Long electrode 70A	(5 pcs)	010556		
■ Diffusore aria-Swirl Ugello - Nozzle (b)	(2 pcs)	010532		
20-50A	(10 pcs)	010528		
70A	(10 pcs)	010531		
Gouging 45A	(10 pcs)	010549		
Gouging 70A	(10 pcs)	010550		
lungo - long 20-50A	(5 pcs)	010557		
lungo - long 70A	(5 pcs)	010558		
■ Porta ugello - Nozzle holder				
standard 70A	(1 pcs)	010535		
ohmic 70A	(1 pcs)	010554		
■ Deflettori - Shields				
Contacto - Contact TC70	(3 pcs)	010541	 <p>70A</p>	
Gouging	(3 pcs)	010551		
Contacto lungo - Long contact	(3 pcs)	010570		
Automatico - Automatic TC70A	(3 pcs)	010542		
■ O-ring	(20 pcs)	010555		
Contacto lungo - Long contact	(20 pcs)	010555		

TC70 PAC 6 m
I-PAC 370 LAB 010520

TC 70A PAC 6 m
I-PAC 370 LAB 010552

TC 70 - TC70A						
Contatto Contact	010541 	010535 - 20/70A 	010528 - 45A 010531 - 70A 	010532 	010527 	 010555 010520 - TC70
Scricatura Gouging	010551 	010535 - 20/70A 	010549 - 45A 010550 - 70A 	010532 	010527 	
Esteso Extended	010570 	010535 - 20/70A 	010557 - 45A 010558 - 70A 	010532 	010556 	 010555 010552 - TC70A
Automatic	010542 	010535 - 20/70A 010554 - 20/70A Ohmic 	010528 - 45A 010531 - 70A 	010532 	010527 	

Starter kit per Torce PAC - PAC torches starter kit		Codice - Code
Torcia - Torch TC70 - TC 70A		
010528 - 45A 010531 - 70A 010527 	STARTER KIT Ugello-Nozzle 20-50A (10pcs) (010528) Ugello-Nozzle 70A (10pcs) (010531) Elettrodo-Electrode (5pcs) (010527)	010854

Torçe PAC e dotazione - PAC torches and equipment

Codice - Code

Codice - Code

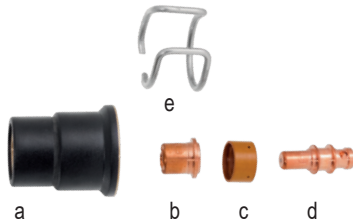

EC A81

■ Porta ugello - Nozzle holder	(a)	(2 pcs)	010120
Ugello - Nozzle	(b)		
∅ 1,0 mm 50A		(10 pcs)	010118
∅ 1,2 mm 80A		(10 pcs)	010119
■ Diffusore aria-Swirl	(c)	(2 pcs)	010117
■ Elettrodo-Electrode	(d)	(10 pcs)	010116
■ Molla distanziale - Spacing spring	(e)	(10 pcs)	010121

EC A81 6m
DI-PAC 90 LAB



80A



EC A101 6 m
D-PAC 120 LAB

010774

EC A101

■ Porta ugello - Nozzle holder	(a)	(2 pcs)	010431
Ugello - Nozzle	(b)		
∅ 1,1 mm 60A		(10 pcs)	010122
∅ 1,4 mm 100A		(10 pcs)	010434
∅ 1,7 mm 130A		(10 pcs)	010433
∅ 3,0 mm Gouging		(10 pcs)	010432
■ Diffusore aria-Swirl	(c)	(2 pcs)	010684
■ Elettrodo-Electrode	(d)	(10 pcs)	010435
■ Molla distanziale - Spacing spring	(e)	(10 pcs)	010425
Distanziale a 2 punte-Spacing bush with 2 feet	(f)	(2 pcs)	010680
Carrello per taglio-Wheeled spacer	(g)	(1 pcs)	010685
Distanziale per scricatura-Gouging spacer	(h)	(2 pcs)	010683
Distanziale taglio contatto-Spacer bearing cutting	(m)	(2 pcs)	010427
Portaugello taglio contatto-Bearing cutting holder	(o)	(2 pcs)	010429

100A

Note tecniche
Technical tips



Macchine per saldatura ad arco elettrico e taglio al plasma

Electric arc welding and plasma cutting machines

Le macchine per saldare ad arco o per tagliare al plasma i metalli trasformano i parametri elettrici della rete di distribuzione in modo da ottenere valori di tensione e corrente idonei per generare un arco di saldatura o taglio.

The machines for metal arc welding or plasma cutting transform the electrical parameters of the distribution network in order to obtain suitable voltage and current values to generate a welding arc or cut. In **TRADITIONAL** solutions, magnetic sheet metal transformers are used at the mains frequency and the working power is regulated by:

Nelle soluzioni **TRADIZIONALI** si impiegano trasformatori in lamierino magnetico alla frequenza di rete e la regolazione della potenza di lavoro avviene tramite:

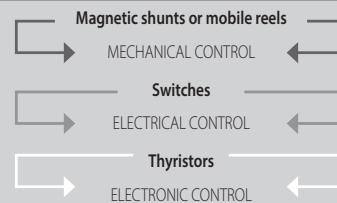
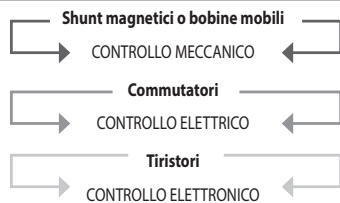

Nell'ultimo decennio del secolo scorso si è affermata una diversa tecnologia per la realizzazione dei generatori alla quale ci riferiamo comunemente con il termine **INVERTER**.

In the last decade of the last century a new technology emerged for the production of generators, which we generally refer to with the term **INVERTER**.

La tecnologia inverter prevede di aumentare la frequenza della corrente alternata prelevata dalla rete (da 50Hz fino a valori di decine di KHz) prima di trasformarla ed ottenere un valore idoneo alla saldatura o al taglio plasma.

The inverter technology implies increasing the frequency of the alternating current taken from the network (from 50Hz up to tens of KHz) before transforming it and obtaining a suitable value for welding or plasma cutting.

La trasformazione di una corrente a frequenza elevata non richiede l'impiego del trasformatore tradizionale in lamierino magnetico, molto grande e pesante, ma di un trasformatore con nucleo in ferrite, piccolo e leggero.

The transformation of a high frequency current does not require the use of a traditional magnetic sheet steel transformer, which is very big and heavy, but a ferrite core transformer, which is small and lightweight.

L'applicazione di questa tecnologia alle saldatrici ed ai generatori per il taglio al plasma permette di produrre apparecchi maneggevoli e di ridotte dimensioni, in grado comunque di erogare correnti di valore elevato.

Through the application of this technology to welding machines and generators for plasma cutting, it is possible to produce easy-to-handle and compact devices, which can still supply high value currents.

Il controllo della potenza degli inverter si effettua in modo elettronico e permette la realizzazione di sistemi molto precisi e stabili, ovvero semplici da usare per gli operatori del settore.

The inverter power is controlled electronically and allows for the implementation of highly precise and stable systems, which are simple to use for operators in the sector.



MMA Saldatura a elettrodo rivestito / Manual metal arc welding

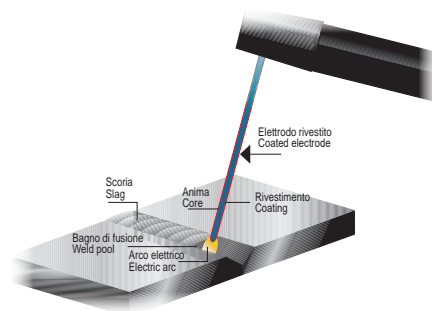

La saldatura ad elettrodo rivestito **MMA** (Manual Metal Arc) sfrutta il calore generato da un arco che scocca tra l'elettrodo ed il pezzo da saldare. E' probabilmente la tecnologia più diffusa a livello mondiale per la saldatura manuale ad arco elettrico.

Manual metal arc welding (**MMA**) exploits the heat generated by an arc which shoots out between the electrode and the piece to be welded. It is probably the most widespread technology in the world for manual electric arc welding.

Con questo procedimento si saldano comunemente tutti i metalli ferrosi, ovvero il **ferro**, i diversi tipi di **acciaio**, compreso l'**acciaio inox**, e la **ghisa**. Con gli altri metalli si ottengono risultati scadenti, per alcuni la saldatura ad elettrodo risulta impossibile. La produttività di questo procedimento è limitata: è necessario interrompere la saldatura quando l'elettrodo è consumato ed occorre sostituirlo, inoltre si deve rimuovere la scoria dopo ogni singola passata.

This process is used to weld all ferrous metals, namely **iron**, various types of **steel**, including **stainless steel**, and **cast iron**. With other metals poor results are obtained. For some of them, manual metal arc welding is impossible. The productivity of this process is limited: it is necessary to interrupt welding when the electrode is worn and this must be replaced. Moreover, the slag must be removed after every single weld.

Vantaggi

- Saldature in qualunque posizione
- Saldature all'interno ed all'esterno
- Maneggevolezza del porta-elettrodo (no gas, no liquidi raffreddamento)
- Apparecchiatura semplice

Advantages

- Welding in any position
- Welding indoors and outdoors
- Handy electrode holder (no gas, no cooling liquids)
- Simple equipment

Svantaggi

- Bassa produttività
- Richiede buona manualità

Disadvantages

- Low productivity
- Requires good dexterity

ARC FORCE

Incremento dinamico della corrente di saldatura quando l'arco diventa troppo corto. Previene l'incollaggio dell'elettrodo al pezzo da saldare. Può essere regolabile dall'operatore, oppure predisposto in fase di progetto in modo che intervenga automaticamente.

ARC FORCE

Dynamic increase of welding current when the arc becomes too short. It prevents the electrode from sticking to the piece to be welded. It can be adjusted by the operator, or arranged during design so that it is engaged automatically.

ANTISTICKING

Riduzione drastica della corrente di saldatura quando l'elettrodo si incolla al pezzo, ovvero la tensione d'arco è nulla per un tempo che supera il limite impostato in fase di progetto. Facilita la rimozione dell'elettrodo dal pezzo da saldare ed evita il surriscaldamento del circuito secondario di saldatura.

ANTISTICKING

Drastic welding current reduction when the electrode sticks to the piece, i.e. the arc voltage is zero for a time that exceeds the limit set during design. It facilitates the removal of the electrode from the piece to be welded and prevents overheating of the secondary welding circuit.

HOT START

Incremento della corrente di saldatura al momento dell'innesco, facilita l'accensione dell'arco. Può essere automatico oppure regolabile dall'operatore.

HOT START

Welding current increase at the time of striking. It facilitates arc starting. It can be automatic or adjusted by the operator.

**TIG**

Saldatura TIG / TIG Welding

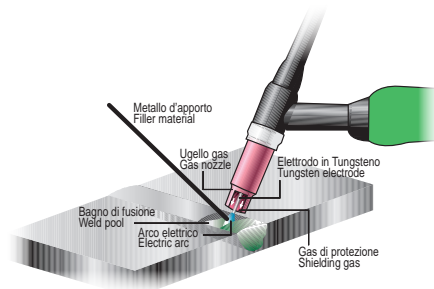

La saldatura **TIG** (Tungsten Inert Gas) sfrutta il calore generato da un arco elettrico che scocca tra il pezzo da saldare ed un elettrodo infusibile di tungsteno, sotto la protezione di un gas inerte, comunemente argon o miscela di Argon-Elio. La saldatura può avvenire senza materiale d'apporto oppure con apporto di materiale che si effettua tramite bacchetta TIG omogenea con il metallo da saldare. Il procedimento TIG può essere impiegato per la saldatura di tutti i metalli, in particolare:

Inox **Rame**
Ottone **Bronzo**
Titanio **Nichel**
Alluminio e sue leghe
Leghe al magnesio

Questo procedimento assicura ottimi risultati meccanici ed estetici, consentendo esecuzioni molto precise. La produttività non è particolarmente elevata.

Vantaggi

Qualità meccanica elevata del giunto saldato
Aspetto estetico del cordone (saldature a vista)
Saldature di precisione
Spessori sottili

Svantaggi

Richiede buona manualità
Bassa produttività
Apparecchiatura complessa

TIG AC

La polarità della corrente di saldatura è alternata (AC = Alternating Current). Il generatore alterna i poli in uscita con frequenza opportuna. Si usa per l'alluminio e per le leghe al magnesio. Si preferisce un elettrodo in tungsteno puro.

TIG DC

La polarità della corrente di saldatura è continua (DC = Direct Current). L'elettrodo ha sempre polarità negativa, la fase di fusione è continua. Si usa per tutti i metalli tranne l'alluminio e le leghe al magnesio. Si preferisce un elettrodo in tungsteno con 2% di cerio.

INNESCO HF

L'innescio dell'arco avviene senza contatto tra elettrodo e pezzo. Evitare tale contatto è importante, perché eventuali residui di tungsteno nel bagno di saldatura possono essere causa di difetti meccanici del giunto saldato.

INNESCO LIFT

Si appoggia l'elettrodo al pezzo e lo si solleva lentamente per innescare l'arco di saldatura, il rischio di contaminazione da tungsteno è modesto.

INNESCO A STRISCIO

Si deve strofinare l'elettrodo sul pezzo per innescare. Si perde precisione e il rischio di contaminazione da tungsteno è elevato.

RAMPA DI SALITA

Tempo in cui la corrente passa dal valore iniziale successivo all'innescio al valore impostato per la saldatura. Consente di evitare un inizio brusco della fusione.

RAMPA DI DISCESA (CRATER FILLER)

Tempo in cui la corrente passa dal valore impostato per la saldatura al valore di spegnimento. Evita la formazione del «cratere» al termine del cordone.

BILANCIAMENTO

Distribuzione del tempo tra fase di pulizia e fase di fusione durante la saldatura TIG AC. A maggiore fusione corrisponde maggiore penetrazione della saldatura, ma minore pulizia del cordone.

FREQUENZA AC

Numero di volte per unità di tempo in cui la polarità dell'elettrodo passa da positiva a negativa e viceversa in TIG AC. Maggiore frequenza corrisponde a cordoni più stretti e maggiore velocità di avanzamento.

BI-LEVEL

La corrente di saldatura passa dal valore impostato a un valore ridotto e viceversa ad ogni pressione del pulsante torcia. Si usa per dosare l'apporto termico al pezzo da saldare evitando crateri e sfondamenti. Molto utilizzato in caso di saldature di oggetti con spessore irregolare.

TIG PULSATO

La corrente di saldatura passa di continuo dal valore impostato (= corrente di picco) a un valore ridotto (= corrente di base) e viceversa. Si usa per dosare l'apporto termico al pezzo da saldare evitando crateri e sfondamenti. Utilizzato in caso di cordoni regolari di spessore sottile.

FREQUENZA PULSAZIONE

Numero di volte per unità di tempo in cui la corrente passa dal valore di picco al valore di base e viceversa in TIG pulsato. Maggiore frequenza corrisponde a cordoni più stretti e maggiore velocità di avanzamento.

PRE-GAS

Tempo durante il quale il gas di protezione esce dall'ugello della torcia prima dell'innescio. Serve a creare un'atmosfera protettiva nella zona dove sta per iniziare la fusione.

TIG welding (Tungsten Inert Gas Welding) exploits the heat generated by an arc which shoots out between the piece to be welded and an infusibile tungsten electrode, under the protection of an inert gas, which is commonly argon or an argon-helium mixture. Welding can be without filler material or with the addition of material through a TIG rod that is homogeneous with the metal to be welded. The TIG process can be used for welding all metals, and in particular:

Stainless steel **Copper**
Brass **Bronze**
Titanium **Nickel**
Aluminum and its alloys
Magnesium alloys

This process ensures excellent mechanical and aesthetic results, with highly precise performance. Productivity is not particularly high.

Advantages

High mechanical quality of the welded joint
Aesthetic look of the seam (visible welding)
Precision welding
Small thicknesses

Disadvantages

Requires dexterity
Low productivity
Complex equipment

TIG AC

The polarity of the welding current is alternating (AC = Alternating Current). The generator alternates the output poles with a suitable frequency. It is used for aluminum and magnesium alloys. A pure tungsten electrode is preferred.

TIG DC

The polarity of the welding current is direct (DC = Direct Current). The electrode always has a negative polarity, and the melting phase is continuous. It is used for all metals except aluminum and magnesium alloys. A tungsten electrode with 2% cerium is preferred.

HF STRIKING

Arc striking occurs without contact between the electrode and the piece. Avoiding such contact is important because any tungsten residues in the welding bath can cause mechanical defects in the welded joint.

LIFT STRIKING

The electrode is placed on the piece and lifted slowly to strike the welding arc; the risk of tungsten contamination is modest.

SCRATCH STRIKING

The electrode must be rubbed on the piece for starting. Lower precision is obtained and the risk of tungsten contamination is high.

SLOPE UP

Time in which the current goes from the initial value following striking to the value set for welding. It prevents an abrupt melting start.

SLOPE DOWN (CRATER FILLER)

Time in which the current goes from the value set for welding to the end-weld value. It prevents the formation of the «crater» at the end of the seam.

BALANCING

Time distribution between cleaning phase and melting phase during TIG AC welding. Higher melt corresponds to greater penetration of the weld, but lower cleaning of the seam.

AC FREQUENCY

Number of times per unit of time when the polarity of the electrode changes from positive to negative and vice versa in TIG AC. Higher frequency corresponds to narrower seams and greater forward speed.

BI-LEVEL

The welding current changes from the set value to a reduced value and vice versa each time the torch button is pressed. It is used to dose the heat input to the piece to be welded avoiding crater and breakages. Widely used in case of welding objects with uneven thickness.

PULSE TIG





The welding current goes continuously from the set value (= peak current) to a reduced value (= base current) and vice versa. It is used to dose the heat input to the piece to be welded avoiding crater and breakages. Used in case of even seams with small thickness.

PULSATION FREQUENCY

Number of times per unit of time in which the current goes from the peak value to the base value and vice versa in pulse TIG. Higher frequency corresponds to narrower seams and greater forward speed.

PRE-GAS

Time during which the protection gas comes out of the torch nozzle before starting. It creates a protective atmosphere in the area where melting is about to begin.

POST-GAS Tempo durante il quale il gas di protezione esce dall'ugello della torcia dopo lo spegnimento dell'arco al termine della saldatura. Serve a proteggere il bagno fuso fino alla completa solidificazione.	POST-GAS Time during which the protection gas comes out of the torch nozzle after the arc switches off at the end of welding. It protects the molten bath until complete solidification.
2T/4T Modalità di funzionamento del pulsante torcia: in 2T il pulsante viene tenuto premuto durante la saldatura, in 4T si preme il pulsante per iniziare a saldare, si salda con il pulsante rilasciato, si preme di nuovo per interrompere la saldatura.	2T/4T Torch button operation mode: in the 2T mode the button is kept pressed during welding; in the 4T mode the button is pressed to start welding, which is then performed after the button is released, and it is pressed again to stop welding.
EASY PULSE by  Regolazione automatica della corrente base e della frequenza di pulsazione in funzione della corrente di picco impostata. Semplifica notevolmente il procedimento di saldatura TIG con corrente pulsata.	EASY PULSE by  Automatic regulation of the base current and the pulsation frequency according to the set peak current. It considerably simplifies the TIG welding process with pulse current.
AC EASY by  Regolazione automatica della frequenza e del bilanciamento dell'onda alternata in funzione della corrente impostata per la saldatura dell'alluminio. Semplifica notevolmente il procedimento di saldatura TIG con corrente alternata.	AC EASY by  Automatic regulation of the frequency and the balance of the alternating wave according to the current set for welding aluminum. It considerably simplifies the TIG welding process with alternating current.

MIG Saldatura a filo continuo / Continuous wire welding

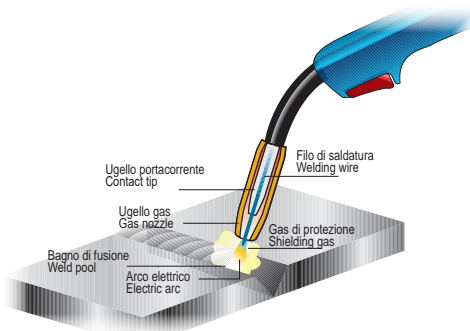

<p>La saldatura MIG/MAG (Metal Inert/Active Gas) sfrutta il calore generato da un arco elettrico che scocca tra il pezzo da saldare ed un filo elettrodo fusibile che costituisce il materiale d'apporto. Il filo è avvolto in bobine di varie dimensioni e deve essere alimentato di continuo nel bagno di saldatura tramite un impianto opportuno. La fusione è protetta dalla contaminazione atmosferica da un flusso di gas inerte (Argon) o attivo (miscela di Argon ed ossigeno, anidride carbonica), condotto nella zona di saldatura tramite la stessa torcia che guida il filo. Il filo è di metallo pieno oppure è costituito da un tubo sottile riempito di flusso granulare fusibile che migliora le caratteristiche meccaniche del giunto saldato. Alcuni tipi di filo tubolare possono essere usati senza protezione gassosa e pertanto vengono identificati con la sigla NO-GAS. Al termine della saldatura con filo animato è necessario rimuovere la scoria in superficie, il filo pieno invece non genera scoria.</p> <p>Il procedimento MIG/MAG si impiega comunemente per la saldatura di:</p> <p>Ferro ed altri acciai non legati Acciai legati ed inossidabili Alluminio e sue leghe</p>	<p>MIG/MAG welding (Metal Inert/Active Gas Welding) exploits the heat generated by an arc which shoots out between the piece to be welded and a fusible wire electrode that constitutes the filler material. The wire is wound in coils of various sizes and must be continuously fed into the welding bath by means of a suitable system. Melting is protected from atmospheric contamination by an inert (Argon) or active (mixtures of Argon and oxygen, carbon dioxide) gas flow, conveyed to the welding area by the same torch that guides the wire. The wire is made of solid metal or consists of a thin tube filled with a fusible granular flow which improves the mechanical characteristics of the welded joint. Some types of tubular wire can be used without gas protection and are therefore identified with the initials NO-GAS. At the end of cored wire welding it is necessary to remove the slag on the surface; instead, the solid wire does not generate any slag.</p> <p>The MIG/MAG process is commonly used for welding:</p> <p>Iron and other non-alloy steel Alloy and stainless steel Aluminum and its alloys</p>
<p>Vantaggi</p> <ul style="list-style-type: none"> - Elevata produttività - No cambio elettrodo - No rimozione scoria (filo pieno) - Buona visibilità del bagno di fusione (rispetto ad MMA) - Spessori alti con passata singola o più passate grazie al deposito elevato - Spessori sottili, diametro minimo filo in commercio 0,6mm 	<p>Advantages</p> <ul style="list-style-type: none"> - High productivity - No electrode change - No slag removal (solid wire) - Good visibility of the melting bath (compared to MMA) - High thicknesses with single weld or more welds, thanks to the high deposit - Thin thicknesses, minimum wire diameter on the market 0.6 mm
<p>Svantaggi</p> <ul style="list-style-type: none"> - Apparecchiatura complessa <ul style="list-style-type: none"> - Generatore corrente - Aspo - Rulli motorizzati per trascinamento filo - Torcia - Bombola gas - Eventuale impianto raffreddamento ad acqua della torcia - La regolazione contemporanea della tensione d'arco, della corrente di saldatura e della velocità di alimentazione del filo al bagno fuso è complicata e richiede esperienza. 	<p>Disadvantages</p> <ul style="list-style-type: none"> - Complex equipment <ul style="list-style-type: none"> - Current generator - Reel - Motorized rollers for wire guiding - Torch - Gas cylinder - Possible water cooling system of the torch - The simultaneous adjustment of the arc voltage, the welding current and the feeding speed of the wire to the molten bath is complicated and requires experience.
<p>SOFT START Tempo in cui il motore del trainafilo passa da fermo alla velocità impostata per la saldatura. Evita partenze troppo brusche. Può essere regolabile dall'operatore, oppure predisposto in fase di progetto in modo che intervenga automaticamente.</p>	<p>SOFT START Time in which the wire guide motor passes from idle to the set welding speed. It prevents abrupt starts. It can be regulated by the operator, or arranged during design, so that it is engaged automatically.</p>
<p>BURN BACK Tempo di ritardo tra l'arresto del motore e l'interruzione della potenza in uscita. Consente la regolazione della lunghezza del filo che esce dall'ugello al termine della saldatura. Può essere regolabile dall'operatore, oppure predisposto in fase di progetto in modo che intervenga</p>	<p>BURN BACK Delay time between motor stop and output power cutoff. It allows adjusting the length of the wire that comes out of the nozzle at the end of welding. It can be regulated by the operator, or arranged during design, so that it is engaged automatically.</p>
<p>HOT START Incremento della corrente durante l'innescio. Facilita l'innescio, in particolare quando si saldano leghe di alluminio. E' presente in genere nelle macchine a tecnologia INVERTER.</p>	<p>HOT START Increase in current during striking. It facilitates striking, especially when welding aluminum alloys. It is usually present in INVERTER technology machines.</p>
<p>PRE-GAS Tempo durante il quale il gas di protezione esce dall'ugello della torcia prima dell'innescio. Serve a creare un'atmosfera protettiva nella zona dove sta per iniziare la fusione.</p>	<p>POST-GAS Tempo durante il quale il gas di protezione esce dall'ugello della torcia dopo lo spegnimento dell'arco al termine della saldatura. Serve a proteggere il bagno fuso fino alla completa solidificazione</p>

2T/4T Modalità di funzionamento del pulsante torcia: in 2T il pulsante viene tenuto premuto durante la saldatura, in 4T si preme il pulsante per iniziare a saldare, si salda con il pulsante rilasciato, si preme di nuovo per interrompere la saldatura.	2T/4T Torch button operation mode: in the 2T mode the button is kept pressed during welding; in the 4T mode the button is pressed to start welding, which is then performed after the button is released, and it is pressed again to stop welding.
SPOOL GUN Torcia particolare che permette di alloggiare la bobina di filo direttamente nell'impugnatura. Evita problemi di scorrimento del filo, in particolare nel caso si usi quello d'alluminio, e permette lunghezze maggiori del cavo torcia. Spesso usata in carrozzeria.	SPOOL GUN Particular torch that allows housing the wire coil directly in the handle. It prevents wire sliding problems, especially in case aluminum wire is used, and allows for greater lengths of the torch cable. Often used in body shops.
MIG-BRAZING Tecnica di saldatura a filo che prevede l'uso di impianti e consumabili che consentono di saldare a temperature non troppo elevate in modo che l'eventuale trattamento di zincatura della lamiera da saldare venga preservato il più possibile. Utilizzata comunemente in carrozzeria.	MIG-BRAZING Welding technique involving the use of systems and consumables that allow welding at not too high temperatures, so that any galvanizing treatment of the sheet to be welded is preserved as much as possible. Commonly used in body shops.
PUNTATURA Modalità di saldatura che permette di eseguire tratti saldati brevi e regolari. In genere si ottiene impostando il tempo di punto ed il tempo di pausa.	SPOT WELDING Welding mode for making short and regular welded sections. This is generally achieved by setting the spot time and the pause time.
SINERGIA Modalità di funzionamento del generatore che permette di regolare contemporaneamente la velocità del filo, la tensione d'arco e l'eventuale frequenza di pulsazione tramite una sola manopola. La relazione tra i vari parametri è fissata opportunamente in fase di progetto.	SYNERGY Operating mode of the generator used to adjust the speed of the wire, the arc voltage and the possible pulsation frequency at the same time through a single knob. The relationship between the various parameters is set appropriately during design.

PAC Taglio al Plasma / Plasma Cutting

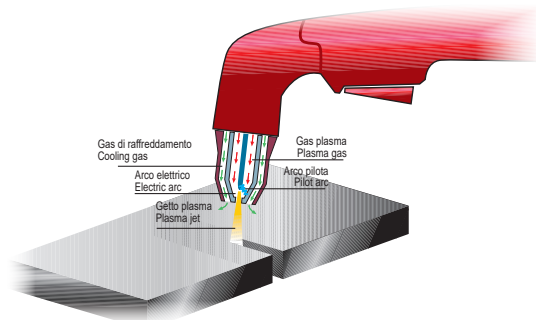

Il plasma è un gas fortemente ionizzato, ovvero composto da particelle cariche, e quindi conduttore di corrente elettrica. Esso può essere ottenuto facendo passare il gas da ionizzare, in genere aria compressa o gas inerte, attraverso un arco elettrico generato all'interno di una strozzatura meccanica. In questo modo la concentrazione delle particelle cariche che si formano aumenta notevolmente, di conseguenza aumenta l'effetto termico e si innalza la temperatura. Il gas ad alta temperatura tende ad espandersi e, attraversando la strozzatura, acquisisce una velocità molto elevata: si ottiene un dardo di cariche ad energia concentrata, utilizzabile per tagliare i metalli.	Plasma is a strongly ionized gas, namely composed of charged particles, and therefore it is an electric current conductor. It can be obtained by making the gas to be ionized, usually compressed air or inert gas, pass through an electric arc generated inside a mechanical bottleneck. This way, the concentration of charged particles is increased considerably, and consequently the thermal effect and the temperature rise. The high temperature gas tends to expand and, through the bottleneck, acquires a very high speed: a dart of concentrated energy charges is obtained, which can be used to cut metals.
Si può realizzare un impianto di taglio al plasma utilizzando un generatore di corrente con caratteristiche opportune, una sorgente di gas ed una torcia che convoglia il gas in un ugello al cui interno viene generato l'arco elettrico.	A plasma cutting plant can be made using a current generator with suitable characteristics, a gas source and a torch which conveys the gas into a nozzle inside which the electric arc is generated.
E' preferibile iniziare il taglio dell'oggetto metallico a partire dal bordo libero del materiale. Se è necessario partire "dal pieno", è opportuno realizzare prima un foro con una tecnica alternativa al taglio plasma. La velocità esecutiva del taglio dipende dallo spessore e dal tipo di metallo. Se la velocità è molto bassa, è difficile ottenere un taglio di qualità.	It is preferable to start cutting the metal object starting from the free edge of the material. If it is necessary to start "from inside", a hole should be made first with an alternative technique to plasma cutting. The cutting speed depends on the thickness and the type of metal. If the speed is very low, it is difficult to get a quality cut.
La velocità di taglio dipende da molte variabili e può solo essere valutata in modo approssimativo in caso di applicazioni manuali.	The cutting speed depends on many variables and can only be estimated roughly in case of manual applications.
A titolo indicativo si riportano due tabelle di corrispondenze tra velocità di taglio espressa in centimetri al minuto, metallo e spessore da tagliare, corrente e diametro dell'ugello.	Below are two tables of correspondences between cutting speed expressed in centimeters per minute, metal and thickness to be cut, current and diameter of the nozzle, provided purely for guidance.
INNESCO SENZA ALTA FREQUENZA L'elettrodo è mobile, il flusso del gas lo stacca dall'ugello e la differenza di potenziale tra elettrodo ed ugello provoca la scintilla d'innescò dell'arco pilota. L'arco pilota viene poi trasferito al pezzo ed inizia il processo di taglio.	STRIKING WITHOUT HIGH FREQUENCY The electrode is movable, the gas flow detaches it from the nozzle and the potential difference between the electrode and the nozzle causes the priming spark of the pilot arc. The pilot arc is then transferred to the piece and starts the cutting process.
INNESCO AD ALTA FREQUENZA L'arco pilota tra elettrodo ed ugello si innescò grazie alla scintilla provocata da un dispositivo che genera una serie di impulsi elettrici a tensione elevata, successivamente l'arco viene trasferito al pezzo ed inizia il processo di taglio.	HIGH FREQUENCY STRIKING The pilot arc between the electrode and the nozzle is primed thanks to the spark caused by a device that generates a series of high voltage electric pulses; the arc is then transferred to the piece and starts the cutting process.
TAGLIO DI QUALITÀ E' un taglio che consente una separazione netta, con bordi regolari e quasi perpendicolari alla superficie dell'oggetto tagliato. In genere si ottiene se la velocità di avanzamento del taglio è costante e non inferiore a 30-40 centimetri al minuto. Per ottenere un taglio di qualità è necessario scegliere un impianto PLASMA che possa separare uno spessore massimo sensibilmente superiore a quello di lavoro.	QUALITY CUTTING It allows a sharp separation, with regular edges almost perpendicular to the surface of the cut object. Generally, it is obtained if the cutting speed is constant and not less than 30-40 centimeters per minute. To obtain a quality cut it is necessary to choose a PLASMA system that can separate a maximum thickness that is significantly bigger than the working one.
SEPARAZIONE MASSIMA E' il massimo spessore che si riesce a separare. Il valore indicato nella documentazione commerciale è generalmente riferito al ferro e non corrisponde ad un taglio di qualità.	MAXIMUM SEPARATION It is the maximum thickness that can be separated. The value specified in the commercial documentation is generally referred to iron and does not correspond to a quality cut.
TAGLIO A CONTATTO Tecnica di taglio in cui l'ugello è a contatto con il pezzo da tagliare. Si usa in genere per spessori non superiori ai 5/6 millimetri.	CONTACT CUTTING Cutting technique in which the nozzle touches with the piece to be cut. It is generally used for thicknesses not bigger than 5/6 mm.

TAGLIO CON DISTANZIALE

Tecnica di taglio in cui l'ugello è mantenuto distante dal pezzo da tagliare tramite l'uso di opportuni distanziatori che si montano all'estremità della torcia. Consente gli spessori di taglio massimi raggiungibili dall'impianto usato.

CUTTING WITH SPACER

Cutting technique in which the nozzle is kept away from the piece to be cut by means of suitable spacers that are mounted at the end of the torch. It allows the maximum cutting thicknesses that can be reached by the system used.

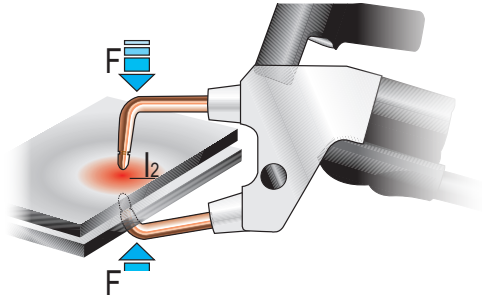
**SPOT****Saldatura a resistenza / Resistance welding**

La saldatura a resistenza sfrutta il calore che si genera nel punto di contatto tra due parti metalliche quando per tale punto passa una corrente elettrica. Il calore sviluppato dalla corrente è proporzionale alla **resistenza elettrica** dei conduttori. Nel punto di contatto tra due oggetti metallici la resistenza è maggiore di quella del metallo, pertanto il passaggio di corrente provoca il surriscaldamento della zona vicina al contatto e, se la corrente è sufficientemente elevata, si arriva alla fusione e quindi alla saldatura dei due oggetti. Il **controllo della saldatura** avviene tramite la **regolazione dell'intensità di corrente e del tempo** durante il quale la corrente attraversa il punto di contatto.

Resistance welding exploits the heat generated at the point of contact between two metal parts when electric current passes through it. The heat developed by the current is proportional to the **electrical resistance** of the conductors. At the point of contact between two metal objects, resistance is greater than that of the metal; therefore, the current being conducted causes overheating in the area close to the contact and, if it is high enough, there is melting and the two objects are welded. **Welding** is controlled by **adjusting the current intensity** and the time during which the current flows through the contact point.

PUNTATURA (SPOT)

La puntatura è un'applicazione di saldatura a resistenza in cui le due parti da saldare sono costituite da due lamiere sovrapposte. Gli elettrodi sono solidali a due bracci meccanici che permettono di stringere con una forza opportuna le lamiere nel momento del passaggio di corrente. Si realizza così l'unione delle lamiere in uno o più punti. Il sistema che manovra i due bracci meccanici può essere di vario genere. Per le applicazioni in **carrozzeria** si usa in genere una pinza pneumatica che può essere facilmente impugnata da un operatore in modo da accedere alle diverse parti del telaio dell'automobile.

SPOT WELDING

Spot welding is a resistance welding application, in which the two parts to be welded are two overlapping sheets. The integral electrodes have two mechanical arms that tighten the sheets with a suitable force when the current is conducted. The sheets are thus joined in one or more spots. The system that maneuvers the two mechanical arms can be of various kinds. For **bodywork** applications, a pneumatic gripper is generally used which can be easily grasped by an operator in order to access the different parts of the car chassis.

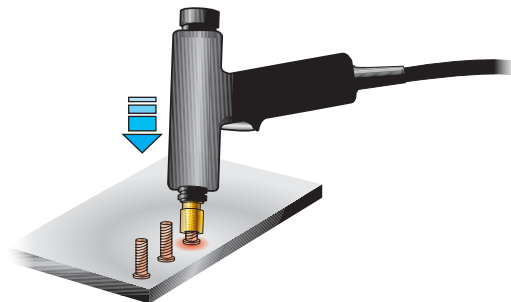
**STUD****Saldatura di perni / Stud welding****SALDATURA DI PERNI (STUD)**

La saldatura di perni è un'applicazione di saldatura in cui le due parti da saldare sono costituite da un perno e da una lamiera metallica. Il perno viene dapprima meccanicamente fissato per un'estremità sulla punta di una pistola opportuna che costituisce il primo elettrodo; l'estremità libera del perno viene appoggiata quindi sul foglio di lamiera a cui è stato collegato il secondo elettrodo.

La forza di contatto è regolata manualmente dall'operatore che impugna la pistola e spinge il perno sulla lamiera, oppure da un sistema a molla. La pressione di un pulsante abilita il passaggio di corrente e la saldatura del perno alla lamiera.

Si saldano in genere **perni di acciaio** con sistemi di saldatura a resistenza ad **energia diretta**.

Per la saldatura di **perni di alluminio** si preferisce l'uso di sistemi ad **energia immagazzinata a scarica capacitiva**: in questo caso la saldatura è più propriamente definita ad arco e non a resistenza ed in effetti è osservabile la scintilla tra perno e lamiera nell'istante del passaggio di corrente.

La saldatura di perni è un'applicazione ricorrente in molti ambiti di carpenteria metallica ed in particolare in **carrozzeria**: i perni saldati sulla lamiera danneggiata di un'automobile, ne consentono il tiraggio e il ripristino alla condizione originale.

STUD WELDING

Stud welding is a welding application, in which the two parts to be welded are a stud and a metal sheet.

An end of the stud is first mechanically fixed to the tip of a suitable gun which constitutes the first electrode; the free end of the stud is then placed on the metal sheet to which the second electrode has been connected.

The contact force is adjusted manually by the operator who grips the gun and pushes the stud onto the sheet, or by a spring system.

Pressing a button enables the current to be conducted and the stud to be welded to the sheet.

In general, **steel studs** are welded with **direct energy** resistance welding systems.

For welding **aluminum studs**, it is preferred to use **capacitive discharge stored energy systems**: in this case welding is more precisely defined arc and not resistance welding, and in fact the spark between stud and sheet can be observed on the moment the current is conducted.

Stud welding is a frequent application in many areas of metal carpentry and in particular in **bodywork**: the studs welded on the damaged sheet of a car allow it to be drawn and restored to the original condition.

La società produttrice declina ogni responsabilità per le possibili inesattezze contenute nel presente catalogo, imputabili ad errori di stampa o di trascrizione.
The manufacturer does not accept any responsibility for any typing or printing errors in this catalogue.



DECA S.p.A.

Strada dei Censiti, 10

Zona Industriale Rovereta

47891 Falciano - Repubblica di San Marino

Tel. da/from Italy **0549 910711**
from other Countries **+378 0549 910711**

Fax da/from Italy **0549 908360**
from other Countries **+378 0549 908360**



www.decaweld.com