

[WWW.ES-TOOLBOX.COM](http://WWW.ES-TOOLBOX.COM)

# Atf SDRIVE 4500

## ATF S-DRIVE 4500



### IT

- **A:** Display a colori touch screen 5'
- **A:** Misura pressione olio uscita cambio
- **B:** Software a icone multilingue
- **C:** Funzione AWS: Correzione automatica peso specifico olio nuovo
- **D:** Funzione warm-up automatico (avvio del ciclo automatico al raggiungimento della temperatura minima ottimale)
- **E:** Lavaggio circuito di aspirazione olio nuovo
- **F:** Nuovo filtro sinterizzato riutilizzabile con magneti
- **G:** Iniezione additivo automatica
- **H:** Possibilità di operare in modo automatico o manuale
- **I:** Aggiornamento software e database via USB
- **J:** Flussimetri illuminati
- **K:** Tanciche olio nuovo/usato
- **L:** Kit raccordi e tubi per vetture europee e asiatiche
- **M:** **SmartPack** (password per accesso gratuito per 12 mesi alla banca dati online)
- **N:** Software cambio olio servosterzi
- **O:** Banca dati integrata con marca, versione, numero rapporti, tipo di cambio, quantità olio

### EN

- **A:** Color touch display 5'
- **A:** Gearbox outlet oil pressure measurement
- **B:** Multilingual software
- **C:** AWS function: Automatic new oil Weight Set
- **D:** Funzione warm-up automatico (avvio del ciclo automatico al raggiungimento della temperatura minima ottimale)
- **E:** Washing of the new oil suction circuit
- **F:** New sintered reusable filter with magnet
- **G:** Automatic additive injection
- **H:** Possibility to operate in automatic or manual mode
- **I:** Software and database updatable via USB
- **J:** Flowmeters with backlight (old/new)
- **K:** New and waste oil tanks
- **L:** Kit of couplings and hoses for European and Asiatic vehicles included
- **M:** **SmartPack** (12 months of free access to the online Database)
- **N:** Software for power steering oil change
- **O:** Integrated database with brand, version, number of ratios, gearbox type, oil quantity, oil code

### S-DRIVE 4500

**COD. 02.023.40**

**ATF SDRIVE**
**Cleaner & Oil Exchanger**

S-DRIVE 4500

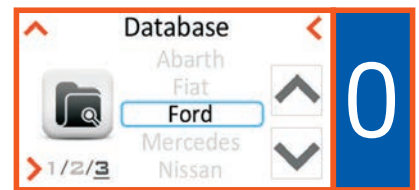
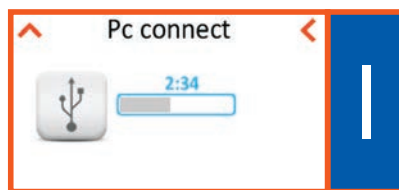
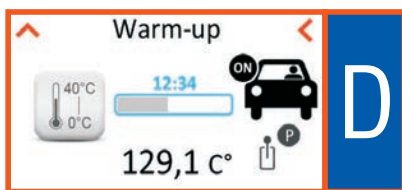

> Le foto sono puramente indicative e possono essere cambiate senza preavviso.  
 > The pictures have merely explanatory purposes and can be changed with no warning.

- A: Pantalla táctil a color de 5"
- A: Medición de la presión del aceite de salida de la caja de cambios
- B: Software multilingüe
- C: Función AWS: Juego de pesas automáticas para aceite nuevo
- D: Función de calentamiento automático (inicio del ciclo automático en alcanzar la temperatura mínima óptima)
- E: Lavado del nuevo circuito de aspiración de aceite
- F: Nuevo filtro sinterizado reutilizable con imán
- G: Inyección automática de aditivos
- H: Posibilidad de funcionamiento en modo automático o manual
- I: Software y base de datos actualizables a través de USB
- J: Caudalímetros con retroiluminación (viejo/nuevo)
- K: Depósitos de aceite nuevos y usados
- L: Kit de acoplamiento y mangueras para vehículos europeos y asiáticos incluido.
- M: SmartPack (12 meses de acceso gratuito a la base de datos en línea)
- N: Software para el cambio de aceite de la dirección asistida
- O: Base de datos integrada con marca, versión, número de relaciones, tipo de caja de cambios, cantidad de aceite, código de aceite

# SMART PACK ATF

## ATF DATABASE ONLINE

**INCLUSO  
CON L'ACQUISTO  
DI OGNI MODELLO ATF**  
valido 12 mesi dall'attivazione

**INCLUDED  
WITH THE PURCHASE  
OF ANY ATF MODEL**  
12 months subscription

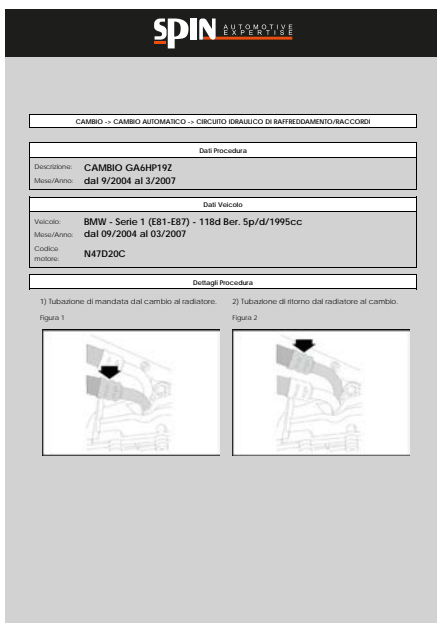

**SMART PACK ATF è un servizio di consultazione della banca dati che raccoglie informazioni tecniche riservate sui cambi automatici:**

- Identificazione rapida del veicolo:
  - ricerca per marca, modello o codice motore
  - ricerca per marca veicolo o codice del cambio
  - ricerche tramite targa veicolo (5 ricerche incluse)\*
- Ubicazione targhetta identificativa (A)
- Ubicazione componenti, procedure e adattamenti (B)
- Informazioni sull'adattatore da utilizzare per collegare il lavacambi ATF al cambio automatico (C)
- Circuito idraulico di raffreddamento
- Controllo livello olio
- Richiesta via mail di informazioni tecniche aggiuntive (10 interrogazioni incluse)\*

*\*Servizio riservato solo per l'Italia*

**SMART PACK ATF is a database consultation service that gathers confidential technical information on automatic transmissions:**

- Quick vehicle identification:
  - search by brand, model or engine code
  - search by vehicle brand or gearbox code
- Location of identification plate (A)
- Location of components (B)
- Information on the adapter to be used to connect the ATF unit to the automatic transmission (C)
- Procedures and adaptations
- Cooling hydraulic circuit
- Oil level check

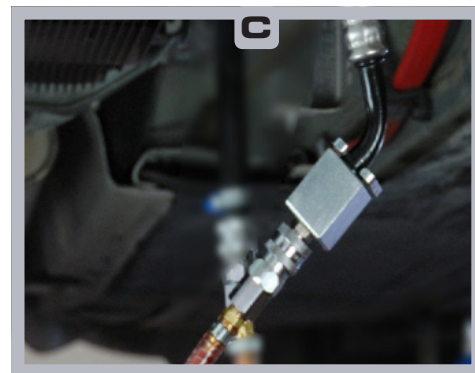
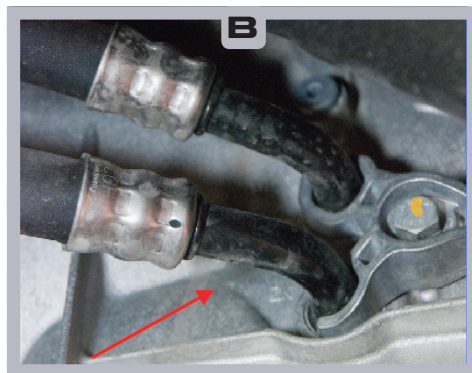
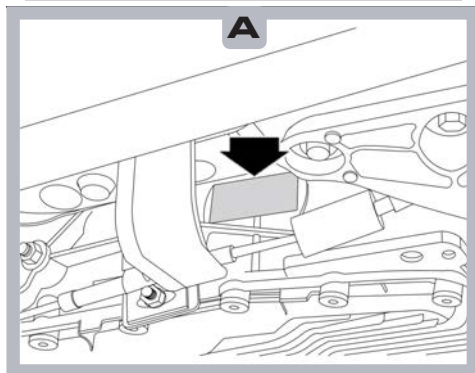

**RINNOVO ANNUALE / ANNUAL RENEWAL**

**Cod. 02.022.110**

**SMART PACK ATF**  
ATF DATABASE ONLINE